



2024

**AFTERMARKET
CATALOG**



WHAT DRIVES US, DRIVES YOUR GROWTH™





SHIPPING & DISTRIBUTION

Hopkins® industry leading brands ship from three main distribution locations, including our centralized distribution center in Edgerton, Kansas. Hopkins® also offers direct import shipping for products manufactured overseas.



Edgerton
Kansas



Miami
Oklahoma



HOPKINS
Canada
Blenheim
Ontario, Canada



For More Information

Call: (800) 524-1458 Fax: (800) 444-6779

To Reach Hopkins® Online Email: sales@HopkinsMfg.com

TABLE OF CONTENTS

NEW PRODUCTS	4
AUTOMOTIVE AIR CARE	10
Hoonigan™ Air Fresheners	12
ARM & HAMMER™ Air Fresheners	14
CLEANING	22
OXICLEAN™ Vehicle Cleaning	24
AutoSpa™ Premium Cleaning	30
The Detailer's Choice® Everyday Cleaning	38
Tanners' Select® Premium Chamois	52
Pacific Coast™ Dusting & Drying	55
Rain-X® Glass Care	56
Mallory® and Carrand™ Squeegees	58
Merchandising	61
TIRE SAFETY & EMERGENCY	62
Genuine Victor™ Sealants & Inflators	65
Genuine Victor™ Guages	68
Genuine Victor™ Repair Kits	74
Genuine Victor™ Valve Caps	77
PROTECTION & CONVENIENCE	80
Body Glove®	82
Hoonigan™ Decals	86
Mossy Oak® Licensed Accessories	88
Bell® Seat Covers	90
DGA™ David Gonzalez Art	93
Bell® Steering Wheel Covers	94
Bell® License Plate Frames & Fasteners	98
Bell® GoGear® Storage & Organization	100
MUD & SPLASH GUARDS	106
AUXILIARY & OFF ROAD LIGHTING	114
Off-Road Lighting & Accessories	116
Auxiliary Lighting	122
Warning & Emergency Lights	130
Fog & Driving Lights	136
Work Lights	138
Reflective Driveway Markers	142
WINTER TOOLS	144
SubZero® & Mallory® Winter Tools	146
Snowbrooms	147
Snowbrushes	151
Frost & Ice Scrapers	155
Pink Tools & Accessories	158
Merchandising	159
FLUID MANAGEMENT	160
Ramps	162
Wrenches	164
Extractors	166
Drains	168
Funnels	170
Siphons & Pumps	173
Absorbents & Squeegees	176
Merchandising	180
LUBRICATION	182
Grease Guns	184
Grease Gun Accessories	188
Fittings	192
Oilers & Misc	200
Transfer Pumps	202
Funnels & Drains	208
SAFETY ACCESSORIES	210
Trailer Rearview Camera	212
Vehicle Hitch Camera	213
Animal Alerts	215
DIY ORGANIZATION	216
HOPKINS TOWING SOLUTIONS®	222
Index	224
CONTACT & SUPPORT	229



NEW PRODUCTS FOR 2024



FRESHEN UP SALES

VENT CLIP CAR AIR FRESHENERS with Odor Elimination Technology

- Morning Breeze**
AH8272MBC
- Outdoor Breeze**
AH8272OBC

PAGE 15



NEW PRODUCTS

These items are manufactured, marketed and distributed by Hopkins Manufacturing Corporation. The ARM & HAMMER trademarks are owned by Church & Dwight Co., Inc., and are used by Hopkins Manufacturing Corporation under license.



OXICLEAN™ Leather-Pro™
2-Sided Leather Cleaning Wipes
 572200C

PAGE
24

Odor Blasters™ Pet-Stain Plus™
 572150C

PAGE
26



These items are manufactured, marketed, and distributed by Hopkins Manufacturing Corporation. The OXICLEAN and Odor Blaster trademarks are owned by Church & Dwight Co., Inc., and are used by Hopkins Manufacturing Corporation under license.

DETAILING YOUR SHOPPERS' NEEDS

AUTOSPA™
 CALIFORNIA CAR CARE



Interior Multi-Tool
 92038AS

PAGE
35



Exterior Multi-Tool
 92048AS

PAGE
35

[HOONIGAN]

SCATTERED FUN



Scatter Seat Cover | PAGE
22-1-73000-9 | 86



Nylon Key Chain | PAGE
22-1-70033-8 | 87



H Block Emblem | PAGE
22-1-70025-8 | 87



Fuzzy Dice | PAGE
22-1-70022-8 | 87



Scatter Seat Belt
Shoulder Pad | PAGE
22-1-70019-8 | 87



Scatter License Plate Frame | PAGE
22-1-46734-8 | 87



BRING THE DRAIN TO THE MESS



FLO TOOL®

13 Quart Extender
Drain Container
42113M1

PAGE
169



SUBZERO[®]
SNOW AND ICE TOOLS

USING THE FORCE HAS NEVER BEEN EASIER!



FORCE[™]

61" BLIZZARD FORCE™
Pivoting Snowbroom
12080

PAGE
147

52" Pivot Head FORCE™
Sport Telebroom™
583-EPRFB

PAGE
150

48" SPORT FORCE™
Snowbroom
581-EFB

PAGE
150



UNFOLDING NEW GROWTH OPPORTUNITES



SHOVEL



SCOOP



3

**LOCKING
POSITIONS**

STORE



ALPINE GEAR™
39" Foldable Auto Emergency Shovel | 17230

PAGE
157

ALPINE GEAR™
40" Folding Snowbrush | 14415

PAGE
151

A FRESH APPROACH TO NEW PROFITS



**RIVETING PRODUCTS AND FRAGRANCES
TO MEET YOUR SHOPPERS' NEEDS**

AUTOMOTIVE AIR CARE

DRIVING INNOVATION

Products that transform the consumer experience

ODOR ELIMINATION

Bad odors are the #1 purchase trigger for automotive air fresheners. That is why we incorporated patented odor elimination technology, with fragrances infused with essential oils

A FRESH MESSAGE

Clean, strikingly modern and easy-to-read packaging, eliminates the confusion and simplifies the shopping experience



[HOONIGAN]

[HOONIGAN]

PURVEYORS OF FINE HOONAGE™



WHO IS HOONIGAN?

QUITE SIMPLY, ANYONE WHO LOVES
HAVING FUN
WITH CARS



Vent Clip-Shield

- Showcasing Hoonigan shield emblem
- Built for a generation of car enthusiasts
- Edgy aesthetics speak to the core audience
- Hoonigan priding itself on authentic products
- Bold masculine scent with odor elimination

HN8200BB- 12 pcs, Open Stock



Vent Clip-Smooth

- Elevating the Hoonigan experience
- Aroma has hints of sandalwood, amber, cardamom and tonka bean all setting the tone for a classy scent
- Gets rid of the stink with odor elimination technology

HN8220BB- 12 pcs, Open Stock

HOON·I·GAN \ HOON'-Î-GEN \ N.

1. A PERSON WHO OPERATES A MOTOR VEHICLE IN AN AGGRESSIVE AND UNORTHODOX MANNER; CONSISTING OF, BUT NOT LIMITED TO, DRIFTING, BURNOUTS, DOUGHNUTS, AS WELL AS ACTS OF AUTOMOTIVE AERONAUTICS. ONE WHO HOONS.



Pit Pass Hanging

- Interactive hanging pit pass
- Hoonigan's classy fragrance for 30 days of freshness
- Double sided artwork

Scattered - HN8000BB - 12 pcs, Open Stock

Logo Mania - HN8001BB - 12 pcs, Open Stock



BUILT NOT BOUGHT

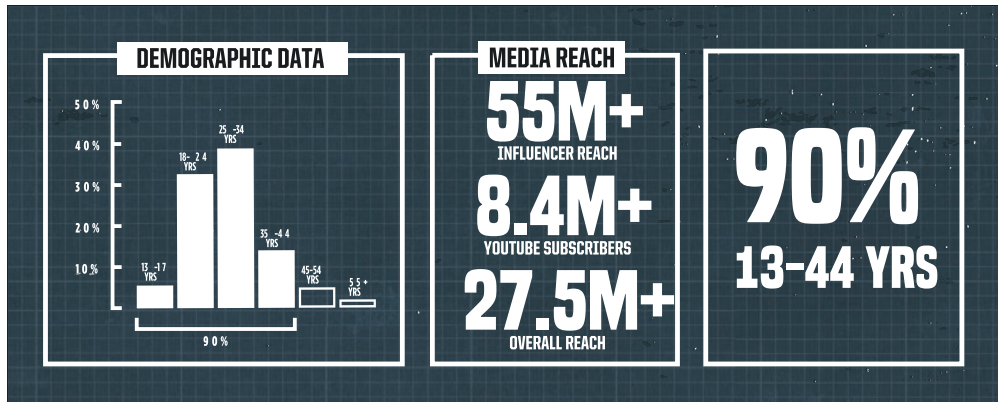

Catch the Hoonigan
Excitement



CAR AIR FRESHENERS

When your shoppers hear the name ARM & HAMMER™... they also hear odor elimination

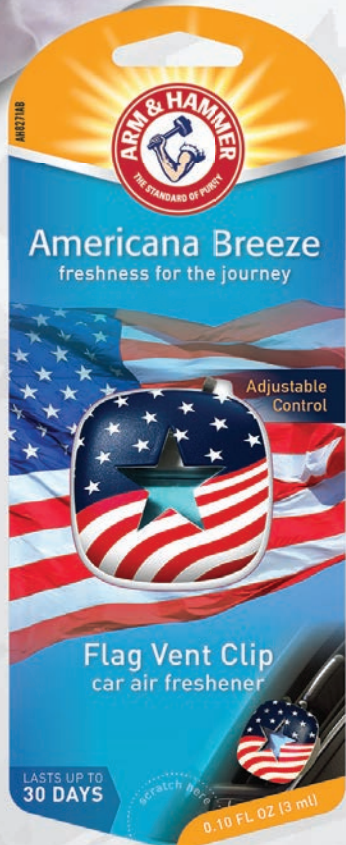

A STAR IS BORN

Flag Vent Clip

- The #1 selling format
- Odor elimination technology
- Refreshing long lasting fragrance

Flag Vent Clip - AH8271AB - 1 pk, 12 pcs. Open Stock

AVAILABLE IN
CLIP STRIPS FOR
YEAR ROUND
PROMOTIONS



EVERYWHERE YOU GO FRESHNESS



NEW

Vent Clips Street Scene

- Odor elimination technology
- Original art inspired by classics
- Easily clips on to any vent for 30 days of freshness

Morning Breeze - AH8272MBC - 12pcs, Open Stock

Outdoor Breeze - AH8272OBC - 12pcs, Open Stock



SPIN FOR A BURST OF FRESHNESS



Scent Spinners Anywhere

- Groundbreaking scent technology
- Fragrance scented beads for a steady flow of aroma
- Spin dial for an extra burst of freshness
- Easily clip onto visor, backseat pocket or on the vent

Great Outdoors - AH8602GO - 12pcs, Open Stock

Black Sea - AH8602BLS - 12pcs, Open Stock

Cabana Breeze - AH8602CA - 12pcs, Open Stock



REV UP TARGETED SHOPPERS



GEARHEAD™ Vent Clips Car Air Fresheners

- Innovative designs inspired by car enthusiasts
- Clever and cool designs to clip on vent
- Available in Classic New Car

Caliper Vent Clip - AH7000C - 1 pk, 12 pcs. Open Stock

Gear Vent Clip - AH7000G - 1 pk, 12 pcs. Open Stock

V-Twin Vent Clip - AH7000V - 1 pk, 12 pcs. Open Stock

Vent Clip - AH7000T - 1 pk, 12 pcs. Open Stock



WITH GEARHEAD™ AIR FRESHENERS

MADE FOR GUYS THAT LOVE THEIR RIDE



GEARHEAD™ Vent Sticks Car Air Fresheners

- Innovative product inspired by car enthusiasts
- Cool and clever design to clip on to vent
- Available in Classic New Car

GEARHEAD™ Vent Stick - AH7100NEC - 2 pk, 12 pcs. Open Stock



BREATHING NEW LIFE INTO LONG LASTING FRESH FRAGRANCES

Patented Odor Elimination Technology and Fragrances Infused with Essential Oils



AMERICANA BREEZE

Lush scents of green meadows and rolling hills with hints of summer florals



BLACK SEA

A fusion of amber and vanilla for a sweet yet salty oceanic fragrance with a hint of citrus, ozone and dark musk



CABANA BREEZE

Colorful blends of coconut, peony and jasmine create an aroma of lush coastal florals



CLEAN BURST™

Nature's garden with hints of jasmine and lilac



GREAT OUTDOOR

A delicate blend of fresh cut roses, lillies and gardenia



ISLAND BREEZE

Charming blends of floral notes, coconut and hints of sea salt



LEMON GRASS

Spunky lemon and rose musk, hints of orange and vanilla. A beautiful herbal fragrance



MIDNIGHT

Intoxicating fusion of musk, patchouli and sage



MORNING BREEZE

Refreshing evergreen smell of lilac, vanilla-cherry with hint of jasmine



MORNING MIST

Top notes of pear, green melon and mandarin, with jasmine and floral aromas



NEW CAR

Reviving freshness with sandalwood and lemon



OUTDOOR BREEZE

Floral notes with water lilies to enhance a cool mid-day breeze



PARADISE

A gateway to an ocean breeze



SEASIDE FRESH

Outdoor freshness with lemons, pines and pure scents of violets and rose



SONORA

Sweet floral desert scent of cactus blooms, a Southwest favorite!



SPRINGTIME

Fresh outdoor aromas of meadows and pine



SUNRISE

Awake your senses with a synergy of aromas featuring sea salt, jasmine and white musk



TAHITI ORCHID

Rich floral island aromas, jasmine and rose pedals

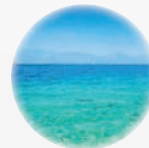

TROPICAL

An oasis of fresh pineapple, mango and coconut



WATER LILY

Fresh, lightly sweet with a hint of lemon





Vent Clip - Gear Shift

- Control the fragrance level with these decorative gear shifts
- New fragrances and styles to meet your personality
- Black carbon fiber design or solid gun metal black

Linen Breeze - AH8351LB - 1 pk, 0.14 oz., 12 pcs. Open Stock
Seaside Fresh - AH8351SF - 1 pk, 0.14 oz., 12 pcs. Open Stock
Citrus Squeeze - AH8351CS - 1 pk, 0.14 oz., 12 pcs. Open Stock
Classic New Car - AH8251CNC - 1 pk, 0.14 oz., 12 pcs. Open Stock



Vent Clip

- Vented front panel allows for full air flow
- Fully adjustable for fragrance control
- Easy to use

New Car - AH8200NEC - 1 pk, 0.14 oz., 12 pcs. Open Stock
New Car - AH8202NEC - 2 pk, 0.14 oz. each, 12 pcs. Open Stock
Springtime - AH8200SPT - 1 pk, 0.14 oz., 12 pcs. Open Stock
Springtime - AH8202SPT - 2 pk, 0.14 oz. each, 12 pcs. Open Stock
Clean Burst™ - AH8200CB - 1 pk, 0.14 oz., 12 pcs. Open Stock
Clean Burst™ - AH8202CB - 2 pk, 0.14 oz. each, 12 pcs. Open Stock



Vent Clip - Camo

- Eye-catching designs for the outdoor enthusiasts
- Fully adjustable for fragrance control
- Easily clips onto any car vent

Midnight - AH8221MID - 1 pk, 0.14 oz., 12 pcs. Open Stock
Midnight - AH8220MID - 2 pk, 0.14 oz. each, 12 pcs. Open Stock
Clean Burst™ - AH8241CB - 1 pk, 0.14 oz., 12 pcs. Open Stock
Clean Burst™ - AH8240CB - 2 pk, 0.14 oz. each, 12 pcs. Open Stock
Sunrise - AH8231SUN - 1 pk, 0.14 oz., 12 pcs. Open Stock
Sunrise - AH8230SUN - 2 pk, 0.14 oz. each, 12 pcs. Open Stock





Vent Clip - Island Leaf

- Inspired by a casual beach scene
- Traditional vent clips with adjustable fragrance control
- Easily clips onto any car vent

Tropical - AH8266TR - 1 pk, 0.14 oz., 12 pcs. Open Stock
Tropical - AH8265TR - 2 pk, 0.14 oz. each, 12 pcs. Open Stock
Paradise - AH8261PAR - 1 pk, 0.14 oz., 12 pcs. Open Stock



Vent Clip - Pets

- Pet friendly fragrances
- Style and scents to enjoy your ride
- Easily clip onto any car vent

Lemongrass - AH8200PAWSRB - 2 pk, 0.14 oz. each, 12 pcs. Open Stock
Morning Mist - AH8200PAWSMY - 2 pk, 0.14 oz. each, 12 pcs. Open Stock
Sonora - AH8263SUN - 2 pk, 0.14 oz. each, 12 pcs. Open Stock



Vent Clip - Blossom

- Floral designs to freshen the mood
- Fully adjustable fragrance control
- Odor elimination technology

Morning Mist - AH8800SUN - 1 pk, 0.14 oz., 12 pcs. Open Stock
Springtime - AH8800SPT - 1 pk, 0.14 oz., 12 pcs. Open Stock
Tahiti Orchid - AH8800TO - 1 pk, 0.14 oz., 12 pcs. Open Stock
Water Lily - AH8800WL - 1 pk, 0.14 oz., 12 pcs. Open Stock



Island Breeze 3-D Novelty

- Style and scent to enjoy your ride
- Fun island inspired designs to hang from mirror
- Double-sided artwork

Sea Turtles - AH8001ST - 1 pk, 12 pcs. Open Stock
Surf - AH8001SU - 1 pk, 12 pcs. Open Stock
Tiki - AH8001TK - 1 pk, 12 pcs. Open Stock





Hide N Scent™

- Maximize freshening power where odors linger
- Combines the power of baking soda with fresh fragrances
- Spill proof package with Flo-Thru technology
- Up to 30 days of freshness

Cabana Breeze - AH8361CA - 12pcs, Open Stock
Midnight - AH8361MID - 12pcs, Open Stock



Under-The-Seat Gel

- Scented gel will not shrink or melt
- Hide-able sturdy container
- Great for auto, home and office

Springtime - AH8500SPT - 3 pk, 12 pcs. Open Stock
New Car - AH8500NEC - 3 pk, 12 pcs. Open Stock
Clean Burst™ - AH8500CB - 3 pk, 12 pcs. Open Stock



Gel Air Freshener

- Slide lever allows for full fragrance control
- See-through container
- Long-lasting gel will shrink for end of life alert

New Car - AH8300NEC - 1 pk, 4.5 oz., 12 pcs. Open Stock
Springtime - AH8300SPT - 1 pk, 4.5 oz., 12 pcs. Open Stock
Clean Burst™ - AH8300CB - 1 pk, 4.5 oz., 12 pcs. Open Stock

MERCHANDISING OPTIONS

Off-Shelf Displays to Attract Your Shoppers

Please Contact Your Sales Rep for Additional Displays Available





CLEANING UP THE CATEGORY WITH INSIGHT AND INNOVATION

POWERFUL INNOVATION THAT DRIVES THE CATEGORY

VEHICLE CLEANING

CATEGORY EXPERTISE

Our industry leading position is the result of our experience and focus. We are committed to quality and the development of 'First To Market' innovations that make DIY car care easier for every consumer

POWERFUL CLEANING TECHNOLOGY

Combining superior design, quality and value with professional grade materials has taken car washing to a whole new level of finish

BRANDED INNOVATIONS

Bring your vehicle cleaning to a whole new level of cleaning with our innovative products that separate us from other competitors

AUTOSPA
CALIFORNIA CAR CARE

THE
DETAILER'S
CHOICE

CARRAND

Mallory

PACIFIC COAST

TANNER'S
SELECT

**OXI
CLEAN**

rainx

OXI CLEAN™

CAR CARE SOLUTIONS

APPEARANCE CHEMICALS & ACCESSORIES

WORK YOUR MAGIC!™

TOOLS THAT TAKE CLEAN TO ANOTHER LEVEL

NEW

OXICLEAN™ Leather-Pro™ Foam Leather Cleaner

- Professional formula surrounds oils and dirt and lifts on contact
- 2-in-1 formula clean and condition
- Deep cleaning with medium sheen
- Gentle leather fragrance

572200C - 6 pcs. Cut Case



OXICLEAN™ Leather-Pro™ 2-Sided Leather Cleaning Wipes

- Dual-Matrix™ technology
- Scrubbing fibers reach deep into surfaces
- Smooth fibers wipe areas clean

440150C - 30 pk, 4 pcs. Cut Case

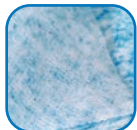

Dual-Matrix™ Technology



OXICLEAN™ Multi-Surface™ Cleaning Wipes

- 2-in-1 scrub and clean
- Scrubbing fibers reach deep into surfaces
- Smooth fibers wipe areas clean
- Made for big jobs

440050C - 30 pk, 2 pcs. Cut Case

440040C - 50 pk, 2 pcs. Cut Case



OXICLEAN™ Multi-Surface™ Cleaning Wipes 7" x 9"

- Dual-Matrix™ technology
- Scrubbing fibers reach deep into surfaces
- Smooth fibers wipe areas clean

440080C - 30 pk, 4 pcs. Cut Case



OXICLEAN™ Interior-Foam™ Carpet & Upholstery Cleaner - 19 oz.

- Stiff sweeping bristles
- Flexible scrubbing bristles
- Spot spray nozzle
- Side grip scallops

572000C - 6 pcs. Cut Case



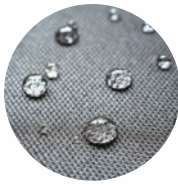

OXICLEAN™ Fabric-Shield™ Water and Stain Protectant Spray - 10 oz.

- Precise spray nozzle
- 360 degree complete coverage
- Ergonomic paddle trigger
- Great for carpet, upholstery, fabric, vinyl and leather

572130C - 6 pcs. Cut Case



OXICLEAN™ Glass-Foam™ & Mirror Cleaner

- OEM Tint Safe
- Tough on bugs
- Streak-free

572080C - 6 pcs. Cut Case



One-Pass™ Sprayer



OXICLEAN™ Complete Wheels™ Wheel & Tire Cleaner - 16 oz.

- Integrated One-Pass™ nozzle
- 360 degrees complete coverage
- Ergonomic paddle trigger
- Side grip scallops

572010C - 6 pcs. Cut Case

OXICLEAN™ Out-Shine™ Ultra Foaming Car Wash - 64 oz.

- Anti-static formula keeps your car cleaner longer
- pH balanced ultra-foaming
- Adds shine and protection

571640C - 6 pcs. Open Stock



OXICLEAN™ Total Wash™ Foaming Car Wash - 100 oz.

- Soaks, softens, and lifts stuck on dirt and debris
- PH balanced ultra-foaming
- Won't remove wax

571000C - 4 pcs. Open Stock



ODOR BLASTING TECHNOLOGY

ELIMINATES ODORS AND FRESHENS EVERYWHERE YOU NEED THE MOST



OXICLEAN™ Odor Blaster™ Cabin & Air Vent Cleaner - 2.8 oz.

- Odor Blasters™ technology resonates with the shoppers need to drive odors out!
- Great for smoke, mildew, sweat, grocery and pet odors
- Leaves a clean fresh scent

572170C - 6 pcs. Cut Case



OXICLEAN™ Odor Blasters™ Rapid-Refresh Spray - 15 oz.

- Quickly eliminates odors
- Great for smoke, mildew, sweat, grocery and pet odors
- Leaves a clean fresh scent

572040C - 6 pcs. Cut Case



OXICLEAN™ Odor Blasters™ Interior-Foam™ Heavy Duty Carpet & Floor Mat Cleaner - 19 oz.

- Bi-Level brush design
- Heavy-duty formula with odor blaster
- Spot scrubber
- Groove cleaning tool

572050C - 6 pcs. Cut Case



NEW

OXICLEAN™ Odor Blasters™ Pet-Stain™ Plus - 15 oz.

- Powerful jet spray
- Integrated spray lock
- Lifting foam formula
- Clean fresh scent

572150C - 6 pcs. Cut Case



OXICLEAN™ Odor Blasters™ Pet-Stain™ Plus - 15 oz.

- Powerful jet spray
- Integrated spray lock
- Lifting foam formula
- Clean fresh scent

572140C - 6 pcs. Cut Case



FROM FABRIC CARE TO EVERYWHERE



OXICLEAN™ Triple Clean™ 3-in-1 Technology Ultimate Wash Pad

- Triple action design
 - Total body cleaning
- 441000C - 6 pcs. Open Stock



OXICLEAN™ Tight-Spot™ 3-in-1 Technology Plunge and Scrub Tool

- Flexible easy reach design
 - Hard to clean areas
- 441260C - 6 pcs. Open Stock



OXICLEAN™ Scrub-Tuf™ Ultimate Scrub Sponge

- Clear coat safe
 - Scrubs stubborn spots and stuck on debris
 - Softens and flexible when wet
- 441050C - 8 pcs. Tray Pack



OxiClean Super-Sudser Ergonomic Wash Sponge

- Contoured shape is easy to hold
 - Ergonomic wave shape is ideal for soap delivery
 - Safe on all surfaces
 - Great for auto, home, RV's, SUV's and more
- 441060C - 8 pcs. Tray Pack



OxiClean Flow Thru Wash Brush Extends to 48"

- Super soft bristles
 - No-Spin locking head with squeegee
 - Telescoping pole
 - On/off water control
- 953010C - 6 pcs. Open Stock



OxiClean Dip-N-Wash Microfiber Wash Mop Extends to 48"

- Super-sudsing microfiber chenille wash mop
 - Extra reach 360 degree swivel design
 - Washable and reusable
- 953020C - 4 pcs. Open Stock



Oxi-Clean Wheel-Scrub Hybrid Wheel Brush

- 2-in-1 wheel and brake dust brush
 - Non-scratch soft bristles
 - Mesh core keeps surface wet
 - Safe on all wheels
- 953050C - 6 pcs. Open Stock

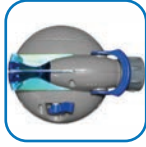

Oxiclean™ Suds-N-Clean™ Foaming Car Wash Spray

- Pro-Foam spray tip
- On/Off soap control
- Lever water control
- Hose connector

953080C - 4 pcs. Open Stock



OxiClean Flex-Flow Soft-Touch Car Wash Hose - 50ft

- Soft touch paint safe
- Rugged fire hose style construction
- Easy on/off swivel-grip connector
- Heavy-duty metal ends

953100C - 4 pcs. Open Stock



OxiClean Total-Clean 3 gal. Wash Bucket with Grit Screen

- Exclusive built-in features
- Grit-Screen separate dirt and debris
- Durable plastic with comfort grip
- Integrated hose clip for easy filling
- Patent pending

953110C - 12 pcs. Open Stock

Oxiclean™ Flex-Dry™ Sof-Touch™ Drying Towel 3-in-1

- Sof-Touch™ drying blades gently sweep water from vehicle surface
- Ultra-Plush™ cut fleece fibers polishes as it dries and wicks moisture from seams and tight spots
- Loop weave fibers gently cleans and brightens emblems, fog lights, mirrors, and glass
- No snag satin edgings

441250C - 6 pcs. Open Stock



OxiClean Total-Drying Microfiber Towel with Pocket

- 5.5 sq.ft. dual-sided plush microfiber drying towel completely dries most vehicles (22" x 36")
- Extra large microfiber completely dries most vehicles
- Corner pocket adds each and control for more complete drying
- No-snag satin edging

441280C - 12 pcs. Open Stock



NEW

OxiClean 30 ct Terry Towels - Heavy Duty & Multi-Purpose

- Premium ribbed 100% cotton terry towels for better cleaning
- Professional grade, soft, absorbent, washable and reusable
- Patent pending Garage-Ready (TM) peg board friendly box design
- Dispenser box packaging
- Towel Size: 12" x 16"

441400C - 6 pcs. Open Stock



NEW

OxiClean 50 ct Microfiber - Cleaning & Detailing Cloths 12"x16"

- Premium ribbed and edgeless microfiber cloths cleans with or without chemicals
- Ribbed texture for better cleaning, dirt lifting and absorbing
- Patent pending Garage-Ready (TM) peg board friendly box design
- Dispenser box packaging
- Towel Size: 12" x 16"

441350C - 6 pcs. Open Stock

POSITION EVERYWHERE YOU NEED IT...



GARAGE-READY™ Peg board friendly box





OxiClean Quick-Clean 3pk Essential Towel Set

- Clean Towel - 3D mesh cleans and scrub with ease
- Dry Towel - 2-sided waffle towel for fast efficient drying
- Detail Towel - Fleece perfect for dusting and detail polishing
- No snag satin edging (14" x 14")

441410C - 12 pcs. Open Stock

OxiClean Fast-Finish 8pk Applicator Set

- Quickly apply waxes, polishes and compounds
- Easy-Grip™ handle keeps hands clean
- 4 Microfiber applicators
- 2 Terry applicators
- 2 Foam applicators
- Great for exterior and interior use
- Washable and reusable
- Patent pending gripper handle

441210C - 6 pcs. Open Stock

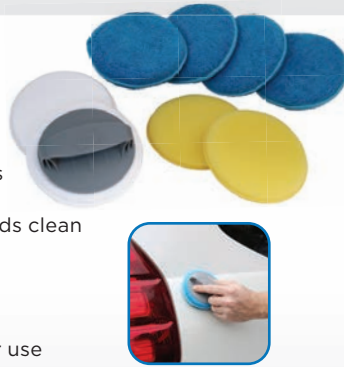

OxiClean Clean-N-Detail 6pk Towels

- Microfiber edgeless towel won't snag or shrink
- Streak and lint-free deep cleaning ribbed design
- Color coded avoids cross contamination of chemicals
- Towel Size: 12" x 12"

441130C - 6 pcs. Tray Pack



OxiClean Clean-N-Detail 18pk Towels

- Microfiber edgeless towel won't snag or shrink
- Streak and lint-free deep cleaning ribbed design
- Color coded avoids cross contamination of chemicals
- Towel Size: 12" x 12"

441140C - 8 pcs. Tray Pack



OxiClean Total-Care 5pk Detailing Towel Set

- Inside and out task specific auto cloths
- Lint-free super absorbent microfiber
- Use towel wet or dry inside and out
- Safe on all surfaces
- Towel Size: 12" x 12"

441170C - 12 pcs. Open Stock



OxiClean Dust-N-Shine 6pk Spa Soft Towels

- 100% polyester microfiber is ultra plush and has a luxury feel
- Cuts through wax haze and quickly lifts surface dust
- Color band edging helps prevent cross contamination of chemicals
- Towel Size: 12" x 14"

441190C - 12 pcs. Open Stock

LUXURY AUTO CARE START TO FINISH
Made for automotive enthusiasts who want nothing but the best when caring for their vehicles; AutoSpa™ Luxury Car Care Accessories prolong the fresh from the showroom feel through superior design, quality, & value.

POWERED CAR CARE... *Better by Design*

Random Orbital Polishers

- Low vibration, heavy-duty motor
- Integrated Multi-Grip™ for reaching and less fatigue
- 3-Layer buffing wheel with visible moisture barrier

6" Professional Polisher 120v Variable Speed Random Orbital

- Heavy-duty 2500 to 5000 opm - 120v motor ETL approved
- 3-layer foam pad with moisture barrier
- Includes foam applicator bonnet, microfiber removal bonnet and wool fine-shine bonnet

94009AS - 2 pcs. Open Stock

PRO POWER

42% faster than standard orbital polishers. Maximizes versatility for a wide range of chemical applications



PRO CONTROL

Electronic throttle for precision motor speed control from 2500 to 5000 opm to deliver power where and when needed



PRO QUALITY



PRO RESULTS



10" Random Orbital Polisher with Bonus Bonnets

- Heavy-duty 3600 rpm-120v motor ETL approved
- 3-layer foam pad with moisture barrier
- Includes foam applicator bonnet and microfiber removal bonnet

94001AS - 1 pc. Open Stock



6" Random Orbital Polisher with Bonus Bonnets

- Heavy-duty 3500 rpm-120v motor ETL approved
- 3-layer foam pad with moisture barrier
- Includes foam applicator bonnet and microfiber removal bonnet

94000AS - 2 pcs. Open Stock



Scan to See
the Auto-Vac
in Action

Auto-Vac 120v Bagless Vacuum

- Heavy-duty 560 watt, 120v motor ETL approved
- Professional in-line air flow design
- Includes carpet, console, crevice and blower tools with handy on-board storage

94005AS - 4 pcs. Open Stock

Sonic-Shine Powered Detailer™

Bring vehicle cleaning and detailing to a whole new level of finish

- Triangular design for superior ergonomics
- Thousands of vibrations per second
- Power surface treatments into the tiniest areas of the vehicle

Omnidirectional vibrations reduce surface tension and make the task quicker and easier. Polish and shine accessory sales with a high tech step-up solution

Sonic-Shine Powered Detailer™

94110AS - 4 pcs. - Open Stock



3-Pack Microfiber Wax & Polish Applicator Pads

- Applies faster and saves time
- Plush microfiber applies paste or liquid waxes and sealants evenly
- Removes with less effort
- Penetrates all parts of the vehicles' finish

45652AS - 3 pk Foam Pads, 6 pcs. Open Stock



1-Pack Scratch Removal and Compound Pad

- Aids in removing light scratches and blemishes
- Faster results when using compounds and polishes
- Safe on all vehicle finishes

45651AS - 1 pk Applicator Pad, 12 pcs. Open Stock



1-Pack Synthetic Wool Polishing Bonnet

- Elastic edge keeps bonnet snug
- Extra soft for buffing and finish polishing
- Excellent for final buffing to shine

40405AS - 9-10" Wool Bonnet, 12 pcs. Open Stock

40404AS - 7-8" Wool Bonnet, 12 pcs. Open Stock

40403AS - 5-6" Wool Bonnet, 12 pcs. Open Stock



2-Pack Microfiber Polishing Bonnet

- Elastic edge keeps bonnet snug
- Premium soft microfiber for removing and polishing
- Excellent for waxes and polishes

40408AS - 9-10" Microfiber Bonnet, 12 pcs. Open Stock

40407AS - 7-8" Microfiber Bonnet, 12 pcs. Open Stock

40406AS - 5-6" Microfiber Bonnet, 12 pcs. Open Stock



1-Pack Foam Application Bonnet

- Elastic edge keeps bonnet snug
- Smooth for professional even application
- Excellent for waxes, polishes and compounds

40411AS - 9-10" Foam Bonnet, 12 pcs. Open Stock

40409AS - 5-6" Foam Bonnet, 12 pcs. Open Stock



Cotton Terry Application Bonnet

- Elastic edge keeps bonnet snug
- Soft for applying and removing
- Excellent for waxes and polishes

45401AS - 9-10" 6 pk Cotton Bonnet, 6 pcs. Open Stock

40402AS - 9-10" 2 pk Cotton Bonnet, 12 pcs. Open Stock

40401AS - 7-8" 2 pk Cotton Bonnet, 12 pcs. Open Stock

40400AS - 5-6" 2 pk Cotton Bonnet, 12 pcs. Open Stock

**Long Pole Leader
Through Features
and Performance**

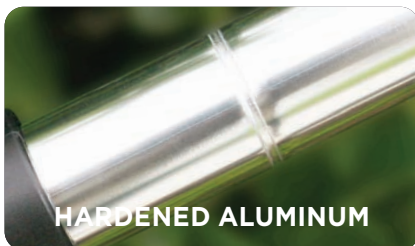

**Professional Flow-Thru™
And Dip Brushes**

This premium accessory market leader helps create step up opportunities to maximize your planogram profits



**Bucketless Car
Wash Solutions**

Bucketless car wash solutions continue to gain marketplace momentum by making it easier than ever to clean passenger and family vehicles. Using our patented on-board soap mixing system with integrated on/off soap control; the bucketless car wash solutions family is the fastest route to a clean vehicle anywhere



On-board soap-mixing chamber



Integrated on/off control



FLOW-THRU

10" Quad Head Wash Brush Extends to 71"

- All-sided quad brush cleans all surfaces easily and quickly
- Telescoping pole with no-spin locking head
- Slide on/off water control

93072- 6 pcs. Open Stock



FLOW-THRU

10" Bi-Level Wash Brush Extends to 71"

- Super soft bi-level brush head with fan spray rinse
- Telescoping pole with no-spin locking head
- Slide on/off water control

93097A - 6 pcs. Open Stock

93097D - 12 pcs. Floor Display



FLOW-THRU™
10" Quad Soap Mixing Brush
 Extends to 55"

- All-sided quad soap brush cleans all surfaces easily and quickly
- Telescoping pole with no-spin locking head
- On/Off control allows for minimal water usage

93977 - 6 pcs. Open Stock



Suds-N-Spray Foaming Wash System™

- Patented exclusive design supercharges any car-wash soap into a professional foam
- Heavy-duty plastic construction with removable Clean-Rinse Nozzle™ Grip

92230 - 2 pcs. Open Stock



FLOW-THRU™
10" Suds-N-Go™ Bi-Level Wash Brush
 Extends to 71"

- Bi-level soap brush with rubber bumpers
- Telescoping pole with no-spin locking head
- Slide on/off water control

93984 - 6 pcs. Open Stock

93984D - 12 pcs. Floor Display



Wash-Jet™ Power Wand

- Easily fills with any car wash soap
- Mixes soap and water automatically - no bucket needed
- Molded rubber protective spray tip, trigger lock and hose swivel control

92215 - 6 pcs. Open Stock



Wash-Jet™ Power Wand with Microfiber Wash Pad

- Easily fills with any car wash soap
- Mixes soap and water automatically - no bucket needed
- Pivoting microfiber wash pad

92216 - 6 pcs. Open Stock



MICROFIBER MAX™
Microfiber Chenille Wash Mop
 Extends to 48"

- Extra absorbent long chenille microfiber wash bonnet
- Telescoping pole
- Wash glove can be removed from pole for professional hand car wash

93303 - 6 pcs. Open Stock



9-Pattern Adjustable Spray Nozzle

- Pro-grade aluminum and brass construction
- Durable powder-coated finish
- Comfort molded TPR grip for superior ergonomics
- Integrated trigger lock ring

90064AS - 3 pcs. Open Stock



Adjustable Jet Spray Nozzle

- Pro-grade aluminum and brass construction
- Durable powder-coated finish
- Comfort molded TPR grip for superior ergonomics
- Integrated trigger lock ring

90065AS - 3 pcs. Open Stock



Hand Tool Innovations Get a Grip on Cleaning Quality Inside & Out

GRIP TECH™

AutoSpa™ Professional Hand Brushes with patented Grip-Tech™ technology bring high-tech design to the hand brush segment

GRIP TECH™

Deluxe Body Brush

- Soft bristles clean wheels, fender and body
- Side protective bumper
- Soft rubber handle for comfort and function

92025 - 6 pcs. Open Stock



GRIP TECH™

Deluxe Tire & Bumper Brush

- Stiff bristles clean bumper, grill and tire
- Soft rubber handle for comfort and function
- Side protective bumper

92036 - 6 pcs. Open Stock



GRIP TECH™

Deluxe Contoured Tire Brush

- Contours to tire shape
- Soft rubber handle for comfort and function
- Can attach to any standard pole

92014 - 6 pcs. Open Stock



GRIP TECH™

Deluxe Tire Brush

- Stiff bristles designed for tires
- Soft rubber handle for comfort and function
- Contours to tire shape

92011 - 6 pcs. Open Stock
92011ASPDQ - 5 pcs. Tray Pack



GRIP TECH™

Deluxe Wheel & Brake Dust Brush

- Strong scour pad action removes brake dust from wheel
- Outer soft bristles clean wheels, while protecting the new wheel finish
- Soft rubber handle for comfort and function

92012 - 6 pcs. Open Stock



GRIP TECH™

Deluxe Double Loop Wheel Brush

- Patented mount design holds bristles
- Soft rubber handle for comfort and function
- Two separate durable bristle loops for complete cleaning

92010 - 6 pcs. Open Stock



GRIP TECH™

Deluxe Interior Brush

- Super stiff bristles to remove dirt from carpet or upholstery
- Flared bristles for hard to reach areas
- Soft rubber handle for comfort and function

92018 - 6 pcs. Open Stock



Bend & Wash™ Wheel Cleaner

- 2-in-1 premium microfiber
- Built-in Bend & Wash™ core for hard-to-reach areas
- Bendable and safe on all surfaces
- 3D scrubbing mesh removes brake dust and debris

97373AS - 6 pcs. Open Stock



GRIP TECH™

Deluxe Dust Pan & Broom

- Wide basin dust pan with rubber edge
- Super stiff bristles for easy cleaning
- Soft rubber handle for comfort and function

92034 - 6 pcs. Open Stock

Professional Specialty Cleaning Tools



INTERIOR



NEW

Interior Multi-Tool

- Patent pending 4-in-1 Multi-purpose interior tool
- Dust and detail vents, console, seat, and seams
- Brushes fold and lock in place
- Folding design for compact on the go storage

92038AS - 6 pcs. Cut case



EXTERIOR



NEW

Exterior Multi-Tool

- Patent pending 4-in-1 Multi-purpose exterior tool
- Scrub and clean badges, trims, tight spots, and spot cleaning
- Brushes fold and lock in place
- Folding design for compact on the go storage

92048AS - 6 pcs. Cut case



4-Pack Grab & Trap Duster Set

- Attracts and traps dust particles
- Easily dust all interior areas
- Compact, folding design
- Comfort grip with hang loop

94026AS - 6 pcs. Open Stock



SPEED-BRUSH™ Drill Brush Set

- Compact for interior and exterior jobs
- Tough scrubbing
- Spot cleaning
- Works with any drill

94208AS - 4 pcs. Open Stock
94210AS - Carpet & Interior 6 pcs. Open Stock
94209AS - Tire & Wheel 6 pc - Open Stock



Wheel Boss™

- Pivoting design reaches places other brushes can't
- Easy-reach wheel brush
- Quick and easy plunge and scrub cleaning

94021AS - 4 pcs. Open Stock

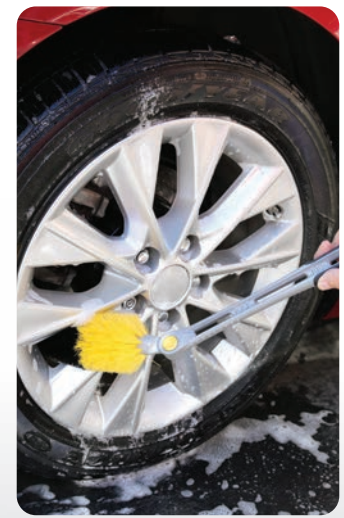

Deluxe Detail Brush Set

- Soft nylon brush for hard to reach areas
- Tough brass for cleaning battery terminals and spark plugs
- Stainless steel for body and bumper rust

92004 - 12 pcs. Open Stock



2-in-1 Electrostatic Detail Brush

- Electrostatic charge picks up dust
- Vent duster brush

92049 - Detail Brush, 12 pcs. Open Stock



MICROFIBER MAX

Body Shine Dusting Wand

- 20" extended reach
- Plush microfiber strands grab and hold surface dust
- Washable and completely reusable
- Cleans car without water and safe on all auto finishes

97370AS - 6 pcs. Open Stock



MICROFIBER MAX

Inside Shine Interior Duster

- Pulls dust from interior surfaces
- Lint free interior dusting
- Keep in car, take anywhere

97372AS - 6 pcs. Open Stock
97372ASPdq - 12 pcs. Tray Pack

MICROFIBER MAX™

Premium Materials Take Car Care To a Whole New Level of Finish

Luxury Chenille Fibers

build suds for a professional wash

Plush Deep Pile Fibers

lift and carry away dirt & debris

Poly-Mesh™ Netting

removes bugs, tar and surface deposits

Luxury Satin Edging

will not snag on wipers, trim or emblems



Sheepskin Wash Mitt

- 92% Sheepskin (Mitt); 8% Polypropylene (Cuff)
- Super deep genuine sheepskin lifts dirt from surface
- Perfect polishing mitt when used dry
- Elastic cuff keeps mitt snug

40305A - 6 pcs. Open Stock



MICROFIBER MAX™

Microfiber Chenille Wash Pad

- Professional detailing
- Easy to grab and wash
- Microfiber super suds maker holds more soap and water

45133 - 6 pcs. Open Stock



MICROFIBER MAX™

Suds-N-Scrub™ Microfiber 2-in-1 Chenille Wash Pad

- Professional detailing
- Easy to grab and wash
- Microfiber scrub netting safely cleans tough spots and debris

45135 - 6 pcs. Open Stock



MICROFIBER MAX™

Total Clean All-Over Body Mitt™

- 4-in-1 waterproof wash mitt
- Suds-maker luxury chenille fibers
- Scratch and lint free professional wash
- Elastic cuff keeps mitt snug

45602AS - 12 pcs. Open Stock

45602ASPDQ - 6 pcs. Tray Pack



MICROFIBER MAX™

Premium Body Sponge

- 2-Sided scrub and wash design
- Plush deep pile fibers for a professional wash
- Poly-Mesh™ netting gently scrubs
- Heavy-duty foam sponge core

45604AS - 12 pcs. Open Stock



50 ft. Easy-Grip™ Car Wash Hose

- Soft touch design
- Easy on/easy off swivel-grip connector
- Heavy-duty firehose style construction
- Professional metal ends

90068AS - 4 pcs. Open Stock

Premium Detailing Accessories

Soft, Absorbent, Versatile...

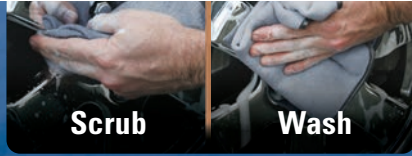

Scrub

Wash



Clean

Dry



Dry

Polish

GLASS | BODY | WHEEL



MICROFIBER MAX™

Supreme Drying Towel

- Super large 5.5 sq. ft. size dries more area faster (22" x 36")
- Scratch, lint and streak free microfiber
- Holds 7 times its weight in water and cleans as it dries
- No snag satin edging

40059AS - 6 pcs. Open Stock
40059ASPDQ - 6 pcs. Tray Pack



MICROFIBER MAX™

Soft Touch Detailing Towel

- 2-Sided towel for interior and exterior dusting, polishing and detailing (16" x 18")
- Plush deep pile luxury fibers
- Scratch and lint free detailing
- No chemicals needed

45606AS - 12 pcs. Open Stock



MICROFIBER MAX™

Quick-Clean Essential Microfiber Towel, 3 Pack

- Clean Towel: 2-Sided scrub & wash
- Dry Towel: 2-Sided super absorbent
- Polish Towel: 2-Sided buff & shine
- No snag satin edging (14" x 14")

45646AS - 12 pcs. Open Stock

Spa-Soft Detailing Towels, 6 Pack

- 100% polyester microfiber is ultra plush and has a luxury feel from the shelf (12" x 16")
- Premium HYDRO-MAX™ treatment makes these towels super absorbent compared to competitors
- Color band edging helps prevent cross contamination of chemicals
- Perfect for washing, drying, polishing and detailing

45625AS - 12 pcs. Open Stock / Tray Pack



SPA-SOFT ADVANTAGE

Absorbs Fast

Spa-Soft with HYDRO-MAX™

Competitors

Slow to Absorb

2x Faster Absorption

No Mess Grip



- 50% faster than hand waxing alone
- Keeps hands clean
- Universal — works on all applicator pads

Patented ergonomic handle and fastening system changes the way wax, polish, and protectant are applied.

Retail Profits Boost 30% Where The Gripper™ is Placed

www.HopkinsMfg.com



The Gripper™ 5 Pack (5") Applicator Set with Reusable Canister

- Multi-purpose applicator pads with no-mess handle
- 3 Microfiber applicators, 2 terry applicators
- Ideal for interior and exterior uses

45128AS - 12 pcs. Open Stock

AUTOSPA™
CALIFORNIA CAR CARE

AUTOSPA™ PREMIUM TOOLS & SOFT GOODS

DETAILING MADE SIMPLE

Easily find the right tools for the job with the usage guide



clean



dry



shine



detail



multi-task



Car Wash Bucket Mega Pack

94108VA - 10 pc. Bucket Kit Includes: 3 ea. Microfiber Towel; 2 ea. Microfiber Applicator Pad; 1 ea. Microfiber Wheel Detailer; 1 ea. Microfiber Wash Mitt; 1 ea. Lug Nut Brush; 1 ea. Gripper Handle; 1 ea. 3 gal. Bucket

94114VA - 4 pc. Bucket Kit Includes: 1 ea. Giant Bone Sponge; 1 ea. Terry Towel; 1 ea. Nylon Bug Sponge; 1 ea. 3 gal Bucket; Lid Not Included

94109VA - 6 pc. Bucket Kit Includes: 3 ea. Terry Towel; 1 ea. 2-in-1 Chenille Mitt; 1 ea. Nylon Bug Sponge and 1 ea. 3 gal. Bucket



3 Gallon (12 Quart) Specialty Car Wash Bucket

- Exclusive design made of high-impact plastic
- Accommodates up to 10" wash brush head
- Ergonomic handle with integrated towel rest

94102N - 36 pcs. Open Stock
94102 - 12 pcs. Open Stock



Professional Grade Water Hose

- Heavy-duty 3-layer construction
- Flexible and easy to maneuver
- Crush resistant ends

90060 - 4 pcs. Open Stock



8-Pattern Trigger Nozzle

- Spray patterns from mist to jet
- Full insulated trigger grip
- Protects hands from hot and cold water

90042 - 10 pcs. Open Stock



Bullet Nose Trigger Nozzle

- Heavy-duty metal core
- Instant on/off action
- Over-molded for added grip and control

90043 - 10 pcs. Open Stock



50 ft. Quick Connect Car Wash Hose with Two Adapters

- Heavy-duty 3-ply kink resistant hose
- Water saving auto shut-off feature
- Universal household hose bib swivel connector

90063 - 4 pcs. Open Stock



Sweeper Nozzle

- Easy action on/off lever water control
- Powerful spray pattern
- Soft TPR over-molded tip
- Fits any standard hose thread

90072 - 24 pcs. Tray Pack



Heavy-Duty Fire Hose Nozzle with On/Off

- Jet sprays over 40 feet
- Adjustable from jet to rinse
- Easy on/off water control

90051 - 6 pcs. Open Stock



Heavy-Duty Fire Hose Nozzle

- Jet sprays over 40 feet
- Adjustable from jet to rinse

90049 - 6 pcs. Open Stock



Heavy-Duty Trigger Nozzle

- Industrial grade nozzle
- Protects hands from hot and cold water
- Threaded tip with protective cap

90016 - 10 pcs. Open Stock



Industrial Trigger Nozzle

- Threaded end for attachments
- Provides on/off and adjustable spray
- All metal construction

90005 - 10 pcs. Open Stock

LONG POLE LEADER

Innovative Long Pole Wash Solutions



Hopkins® is the market leader in the ever-growing long pole wash category. Our exclusive designs have innovative features that cannot be found on any competitor's product. Over 50 years of car care experience in packaging, brush fibers, spray patterns and pole configurations gives customers virtually unlimited choices for their car care needs

RELENTLESS INNOVATION...

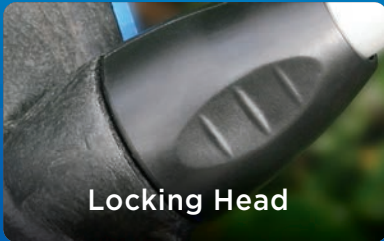

Locking Head



ABS Components



Hardened Aluminum



FLOW-THRU 8" Wash Brush with Extension Pole

- Super soft brush with fan spray rinse and rubber bumpers
- Telescoping pole with on/off water control

92022S - 8" Brush with 40" Pole, 6 pcs. Open Stock

93052 - 8" Brush with 65" Pole, 6 pcs. Open Stock

93055 - 8" Brush with 28" Pole, Not Extendable,
6 pcs. Open Stock



10" Wash Brush Extends to 65"

- Super soft brush with rubber bumpers
- Telescoping pole
- Foam grips for extra control

93062 - 8 pcs. Open Stock

93062D - 12 pcs. Floor Display



8" Wash Brush Extends to 48"

- Super soft brush with rubber bumpers
- Telescoping pole

93063 - 6 pcs. Open Stock



FLOW-THRU™
10" Wash Brush Extends to 68"

- Super soft brush with fan spray rinse and rubber bumper
- Telescoping pole with no-spin locking head
- Variable-slide water control

93089A - 6 pcs. Open Stock

93089D - 12 pcs. Floor Display

...YIELDS SUPERIOR PRODUCTS

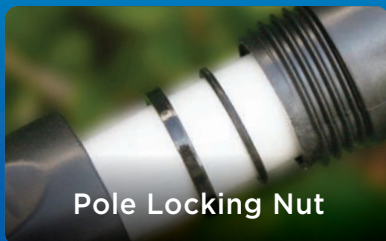

Pole Locking Nut



Press-Fit Connections



Slide Water Control



8" Bi-Level Wash Brush with 48" Pole

- Super soft bi-level wash brush
- Super strong all metal pole
- Plastic molded grip

93060 - 6 pcs. Open Stock

93060D - 12 pcs. Floor Display



Wash Brush with 48" Pole

- Super soft brush with rubber bumper
- Super strong all metal pole with plastic molded grip

93058 - 10" Brush, 6 pcs. Open Stock

93053 - 8" Brush, 6 pcs. Open Stock

93058D - 10" Brush, 12 pcs. Floor Display

93053D - 8" Brush, 12 pcs. Floor Display



HAND TOOL INNOVATIONS

Setting the Standard for Cleaning Quality Inside and Out



Over-Molded Grip



Long Handle Brush 20"

- Extra-long handle for wheel and body
- Super-soft bristles
- Comfort-molded handle

93039 - 20" Body Brush, 12 pcs. Open Stock

94039 - Over-Molded Grip, 12 pcs. Open Stock



Over-Molded Grip



Wheel & Bumper Brush

- Soft-bristles clean wheel, bumper and body
- Comfort-molded handle

93025 - 6 pcs. Open Stock

94025 - Over-Molded Grip, 6 pcs. Open Stock



Over-Molded Grip



Tire & Grill Brush

- Stiff bristles clean bumper, grill and tire
- Comfort-molded handle

93036 - 12 pcs. Open Stock

94036 - Over-Molded Grip, 12 pcs. Open Stock



Plunge & Scrub Spoke Brush

- All-sided cleaning
- Safe with most wheel finishes
- Comfort-molded handle

94037 - 12 pcs. Open Stock



Microfiber Wheel Detailer

- Super-soft microfiber detailer with side scrubbing panels
- Comfort-molded handle
- Safe on all types of wheels

92017 - 6 pcs. Open Stock



Wheel Brush

- Non-scratch soft bristles
- Safe with most wheel finishes
- Comfort-molded handle

93012 - 12 pcs. Open Stock





Contoured Bristles



Contour Tire Brush

- Super-stiff bristles designed for tires
- Contours to tire shape
- Comfort-molded handle

93027 - 6 pcs. Open Stock



Deluxe Tire Brush

- Super-tough brass bristles
- Cleans white/black wall tires and corrosion
- Thumb and finger position for extra scrubbing pressure

92016 - 6 pcs. Open Stock



Lug Nut Brush

- Patented design cleans all sides of lug nut quickly and easily
- Works on all detailing areas of wheel, lug nut-stem-rim
- Fits all lug nut sizes

92019 - 6 pcs. Open Stock

92019WR - 12 pcs. Off Shelf/Wire Basket



Finger Loop Scrub Brush

- Curved bristles clean crevices quickly and easily
- TPR rubber sure grip

92047 - 12 pcs. Open Stock

92047WR - 12 pcs. Off Shelf/Wire Basket



12" Car Dryer

- Squeegee car dryer with non-slip comfort grip handle
- 12" flexible, high quality, silicone blade car dryer

63128 - 6 pcs. Open Stock



Tire Shine Applicator

- Quickly and easily applies tire dressing
- Contours to tire shape
- Comfort-molded handle

93047 - 6 pcs. Open Stock



EZ Grip Applicator Sponge

- Contoured, easy grip sponge handle
- Suitable for all application uses

9-328 - 12 pcs. Open Stock



Contour Tire Wipe

- Handle keeps hands away from chemicals
- Contoured handle shapes foam to the tire surface

92043 - 1 pk, 6 pcs. Open Stock

92043WR - 12 pcs. Off Shelf /Wire Basket

92143 - 2 pk, 6 pcs. Open Stock



Over-Molded Grip



Interior Brush

- Durable scrubbing bristles
- Stiff carpet brush
- Easy-grip handle

94018 - Over-molded grip, 12 pcs. Open Stock



Dash and Crevice Detail Brush Set

- 2-Sided vent louver detailer
- Dust and crevice brush
- Vent and seam detailer

93019 - 12 pcs. Open Stock



Interior/Exterior Detail Brush

- Soft bristles are perfect for dusting vents and dash and hard to get areas
- TPR tip removes dirt and grime from seams

92046 - 12 pcs. Open Stock

92046WR - 24 pcs. Off Shelf/Wire Basket



Vent Brush

- Removes dust and dirt from hard to reach areas
- Stiff natural fibers

93043 - 12 pcs. Open Stock



Detail Brush

- Dash dusting fibers
- Vent and detail brush
- Perfect for vents and seams

93044 - 12 pcs. Open Stock



Lint & Hair Removal Brush

- Electrostatic bristles attract hair and fur like a magnet
- Removes hair, lint, and fuzz from upholstery and carpets
- Natural-rubber bristles will not scratch or scuff

93112 - 6 pcs. Open Stock



Dust Pan & Broom

- Plastic pan and broom set
- Assorted colors

4B3208 - 12 pcs. Open Stock



Whisk Broom

- Use in home or vehicle
- Natural fibers
- Metal hanger loop

93028 - 6 pcs. Open Stock



Push Broom

- Great for indoor or outdoor applications
- Durable head with outer split-tip bristles
- 60" steel handle with hanging feature
- Use wet or dry

93071 - 24" broom, 6 pcs. Open Stock

6018 - 18" broom, 6 pcs. Open Stock



Parts Brush

- General purpose brush
- Effective for all parts dusting and cleaning
- Firm bristles
- Multi-surface cleaning

4B3278 - 12 pcs. Open Stock



Window Wash Spray Squeegee

- Refillable, easy pump spray
 - Side mount scraper
- 9025CDF** - 12 pcs. Open Stock/Tray Pack



Compact Window Squeegee 8"

- Handle extends to use and collapses to store
 - Compact design stores anywhere
 - Double scrubbing action
- 9038** - 6 pcs. Open Stock



Side scrub netting



Microfiber 3-in-1 Wheel & Body Wash Mitt

- Waterproof lining keeps hands dry and clean
- 2-Sided for separate body and wheel cleaning
- Side microfiber scrub netting safely cleans tough spots and debris

40310 - 6 pcs. Open Stock



Microfiber Long Chenille Wash Mitt

- Long microfiber super suds maker holds more soap and water
- Cleans like a mop without snagging on crevices
- Elastic cuff keeps mitt snug

40309 - 6 pcs. Open Stock



Ultimate Microfiber Mitt

- Dense pile cleans away dirt and grime
- Foam lined for added comfort and absorbency
- Use dry for dusting and wet for washing
- Ideal for polishing and dusting exterior and interior of your vehicle

2-303M8 - 6 pcs. Open Stock



Super Sudsmaker Microfiber Wash Mitt

- Performance chenille super suds maker, holds more soap and water
- Convenient side for scrubbing
- Two mitts in one

45320 - 6 pcs. Open Stock



Microfiber Wash Mitt

- Suds maker super absorbent microfiber
- Lint, streak and scratch free cleaning
- Sponge lined for extra absorbency

40307 - 6 pcs. Open Stock



Microfiber Mesh Wash Mitt

- Plush microfiber lifts and traps dirt & dust
- Strong microfiber mesh scrubs away tough dirt
- Dual textured design allows you to clean most surfaces without sprays, polishes, or chemicals
- Plush microfiber side can be used dry for dusting and wet for washing

2-3268 - 12 pcs. Open Stock



2-in-1 Supersoft Microfiber Wash Mitt

- Chenille microfiber lifts and traps dirt and dust
- Strong microfiber mesh scrubs away tough dirt
- Mesh side for gentle scrubbing, plush side for washing

2-310M8 - 6 pcs. Open Stock



Chenille Wash Mitt

- Super suds deep pile chenille perfect for any surface
- Elastic cuff keeps mitt snug

40302 - 6 pcs. Open Stock



Chenille 2-in-1 Wash Mitt

- Super suds deep pile chenille perfect for any surface
- Elastic cuff keeps mitt snug
- Bug scrub netting

40304 - 6 pcs. Open Stock



Acrylic Wool Wash Mitt

- Synthetic wool is extra soft and dense
- Great suds maker
- Elastic cuff keeps mitt snug

40306 - 6 pcs. Open Stock



Microfiber Sponge with Added Scrub

- Large microfiber chenille pad for washing
- Two products in one
- Microfiber dog bone sponge has scrubbing mesh for bug and tar removal

45114 - 9 pcs. Open Stock



2-in-1 Microfiber Covered Bone Sponge

- Plush microfiber cleans away dirt and grime
- Microfiber mesh scrubs away tough dirt
- Mesh side for gentle scrubbing
- Plush side for washing

9-21M8 - 12 pcs. Open Stock

9-21M8-7 - 12 pcs. Cut Case



Microfiber 2-in-1 Long Chenille Sponge

- Long microfiber super suds maker holds more soap and water
- Scrub side removes bug and tar from windows and mirrors
- Super absorbent sponge

40112 - 12 pcs. Open Stock



Chenille Shampoo Wash Pad

- Dense chenille pile is sewn over an absorbent sponge, creating more sudsing action
- Super sudsing action
- Washes without scratching
- Safe on all surfaces

9-368 - 6 pcs. Open Stock



Microfiber Bone Sponge

- Sudsmaker super absorbent microfiber material
- Lint, streak and scratch-free cleaning
- Super absorbent sponge

40110 - 12 pcs. Open Stock



Bone Sponge

- Extra absorbent and durable
- Bone shape is easy to hold
- Extra large sponge

40102 - 12 pcs. Open Stock

9-38 - 24 pc. Open Stock

9-38-7 - 14 pc. Cut Case



Large Bug-Gone Scrubber Sponge

- Removes bug and tar stains
- Use on windshields, headlights and windows
- Super scrubbing action
- Strong and long lasting mesh-covered sponge is designed to replace steel wool and other harsh pads

9-248 - 12 pcs. Open Stock



Nylon Bug Sponge

- Sponge with stiff netting safely scrubs bugs and tar from windows and mirrors
- Compact size fits easily into palm
- Extra absorbent

40106 - 12 pcs. Open Stock



Microfiber Bug Scrubber

- Removes bug and tar stains
- Microfiber mesh covered sponge
- Tough on dirt yet safe to use on all surfaces
- Strong and long lasting mesh-covered sponge is designed to replace steel wool and other harsh pads

9-24M8 - 12 pcs. Open Stock



Microfiber 2-in-1 Wheel Detailer Wash Mitt

- 2-in-1 microfiber detailer safely cleans painted and clear coated wheels
- 2-Sided microfiber pockets give cleaning power to fingers
- Microfiber reinforced scrub panel quickly cleans away brake dust and road grime

40313 - 12 pcs. Open Stock



Microfiber Screen & Display Cleaner

- 2-Sided for dash dusting and window and mirror defogging
- Pockets hold mitt to fingers to reach along window edges
- Suede for window and mirror; terry microfiber for dusting

40314 - 12 pcs. Open Stock



MADE FOR AUTO CARE

Thousands of split fibers per square inch provide an ultra soft, lint, streak, and scratch-free way to clean, dry, shine, detail, and more. Round corners won't scratch or snag like traditional microfiber towels, perfect for cleaning all parts of the vehicle... inside and out!



50 ct Edgeless Microfiber Towel

- Micro-Line Edgings - won't snag or shrink
- Superior polishing, drying and detailing
- Extra durable and lint free, use for any car care task
- Easy to use dispensing box package
- Towel size: 12" x 12"

45068 - 6 pcs. Open Stock



Multi-Pack Microfiber Towels

- Superior polishing, drying and detailing towel
- Extra durable and lint-free
- Use for any car care task
- Towel size: 12" x 16"

40062 - 8 pk towels, 12 pcs. Open Stock

45067 - 12 pk Assorted Colors, 6 pcs. Open Stock

40062D - 12 pcs. Tray Pack

3-517-78 - 12 pk bagged - 6 pcs. Cut Case



3-Pack Microfiber Towels

- Superior polishing, drying and detailing towel
- Extra durable and lint-free
- Use for any car care task
- Towel size: 12" x 16"

40061 - 12 pcs. Open Stock

40061D - 25 pcs. Tray Pack

3-6068 - 6 pk. rolled, 12 pcs. Open Stock

3-5038 - Rolled, 12 pcs. Open Stock

3-5038-7 - 12 pcs. Open Stock



18 pc. Microfiber Cloth

- Ideal for auto, home, office, and marine applications
- Soft and lint-free - Safe on all surfaces
- Lifts and traps dirt and dust like a magnet
- No chemicals needed
- Towel Size: 12" x 12"

3-5418 - 12 pcs. Open Stock



Wash and Dry Microfiber Cloth

- Cleans without chemicals
- Absorbs 8 times its weight in water
- Towel size: 16" x 16"

45070 - 12 pcs. Open Stock



Glass and Dusting Microfiber Cloth

- Lifts and locks dust within fabric
- Can be used wet or dry
- Ultra soft
- Clear coat safe
- Towel size: 12" x 16"

45066 - 12 pcs. Open Stock



2-Pack Glass Pocket Towel

- Gives a streak-free and spotless finish - safe on all surfaces
- Corner pocket for greater control
- Great for removing dirt and greasy fingerprints from glass, mirrors or any reflective surface
- Uniquely designed microfiber lifts and traps dirt and dust like a magnet - no chemicals needed
- Easy care- machine wash & dry

3-5118 - 12 pcs. Open Stock



Deluxe Microfiber Large Drying Towel (22" x 30")

- Professional weave creates more drying sides and edges
- Super large size dries larger area quickly
- Lint and streak free drying
- Cleans as it dries and safe on all surfaces

45211 - 6 pcs. Open Stock
3-5158 - 6.25 sq. ft., 6 pcs. Open Stock



9 Sq Ft Microfiber Heavy Plush Towel

- Extra large, super soft, and absorbent
- Traps and holds dust like a magnet
- Ideal for exterior/interior of your vehicle
- Clear coat safe

3-5068 - 6 pcs. Open Stock



2-in-1 Plush Microfiber Wax & Buff Towel

- Removes wax build-up
- Super soft plush side is great for buffing
- Towel size: 16" x 16"

3-5078 - 6 pcs. Open Stock



2 pc. Microfiber Spa Towel

- Super soft
- Ideal for polishing and dusting
- Clear coat safe
- Towel size: 16" x 16"

3-5088 - 12 pcs. Open Stock



Microfiber Max Drying Towel (24" x 30")

- Textured design creates more drying surface
- Lint and streak free drying
- Super large size dries large area fast
- Cleans as it dries and safe on all surfaces

45010 - 6 pcs. Open Stock
3-5028 - 5 sq. ft. Microfiber Waffle Drying Towel, 12 pcs. Open Stock

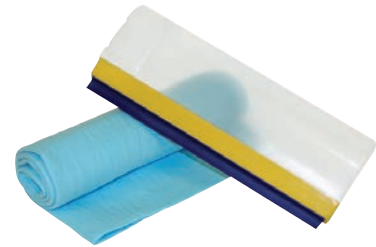

Evaporator PVA Drying Towel w/Wipe-Out Blade Canister

- Durable PVA towel with center mesh absorbs water like a sponge
- Wipe out silicone blade removes water from body and window

40208 - 3 sq. ft., 6 pcs. Open Stock
40209 - With Wipe out Blade Canister, 6 pcs. Open Stock



Synthetic Chamois

- Streak and spot free drying
- Requires less effort to dry all surfaces
- Extra durable, easy to wring out and re-use

40211 - 3.5 sq. ft. 12 pcs. Open Stock
40210 - 2.5 sq. ft. 6 pcs. Open Stock



Polishing & Wax Removal Cloth

- Removes streaks, haze, dust and wax residue
- Towel size: 14" x 18"

45069 - 12 pcs. Open Stock



3 pc. Microfiber Glass Towels (14" x 14")

- One towel each for washing, scrubbing, and glass cleaning
- Blue - Cleans glass and mirrors lint-free
- Gray - Scrubs away bugs and tar stains and caked-in debris
- Green - Use wet to wash, dry to dust and polish

3-5018 - 12 pcs. Open Stock



2-Pack Microfiber Cleaning Cloth (12" x 16")

- Works like a magnet to attract and hold dust
- Great for dusting, windows and polishing
- Microfiber technology

3-5108 - 12 pcs. Open Stock



Microfiber Cleaning Cloth (12" x 16")

- Works like a magnet to attract and hold dust
- Great for dusting, windows and polishing
- Microfiber technology

45063 - 12 pcs. Open Stock



12 pcs Microfiber Towel (14" x 14")

- Scoops, lifts, and traps dust and dirt
- Cleans without chemicals
- Use wet or dry
- Safe on all surfaces

3-5128 - 18 pcs. Open Stock



The Gripper™ 2-Pack Microfiber Applicator Set (5")

- The Gripper™ handle holds tight to pad with fastening hooks
- No-mess application of interior protectants and more
- Completely reusable handle

40123 - 6 pcs. Open Stock



The Gripper™ 3-Pack Terry Applicator Set (5")

- The Gripper™ handle holds tight to pad with fastening hooks
- No-mess application of wax and polish
- Completely reusable handle

40122 - 6 pcs. Open Stock



Foam Applicator Pads

- Designed to evenly apply wax, polish, protectant, stain and wood finish to all surfaces
- Soft and lint-free

9-198 - 12 pcs. Open Stock



2-Pack Terry Cloth Applicator Pads (5")

- Lint-free, extra soft terry cloth
- Great for applying wax, polish and more
- Refills for The Gripper™ packs

40118 - 2 pk, 12 pcs. Open Stock

40119 - 4 pk, 12 pcs. Open Stock

9-288 - 2 pk, 12 pcs, Open Stock (4.5")



2-Pack Microfiber Applicator Pads (4.5")

- Lint-free and streak-free
- Holds more protectant, polish and wax
- Extra absorbent and soft

9-28MC8 - 2 pk, 12 pcs. Open Stock



6 in. Terry Applicator with Pocket

- Terry covered pad designed for easy application of protectants, waxes, stains, wood finishes and polishes to all surfaces
- Convenient hand pocket
- Soft and lint-free cotton

9-278 - 12 pcs. Open Stock



6 in. Microfiber Applicator with Pocket

- Soft and lint-free microfiber
- Large size applies wax, polish, and protectant quickly and evenly
- Sewn pocket adds grip and control

9-27MC8 - 12 pcs. Open Stock

9-26-7 - with Mesh Pocket - 12 pcs Cut Case



1 lb. Microfiber Assorted Towels

- Soft and lint-free
- Lifts and traps dirt and dust like a magnet
- Multiple colors for different wiping applications
- Machine washable and reusable

2-3548 - 16 pcs. Open Stock



6 oz. Polishing Cloth

- Super soft knitted polyester cloth
- Perfect for polishing, waxing, and buffing
- Clear coat safe

2-48 - 6 pcs. Open Stock

POLISHING & DETAILING

Core and Essential Solutions for Complete Auto Care



Diaper Soft

Wax Removal and Exterior Polishing

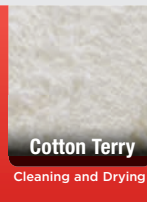

Cotton Terry

Cleaning and Drying



Cotton Flannel

Super Soft Polishing Inside and Out



Cotton Shop

Absorbing and Clean Up



Flannel Cloth 3-Pack (14" x 24")

- Provides the ultimate high gloss shine
- Ultra soft and safe for all clear coats

3-7438 - 24 pcs. Open Stock



Diaper Soft Polishing Cloths (11" x 17")

- Super soft for wax removal and polishing any surface
- Washable and reusable

40065 - 3 pk rolled, 12 pcs. Open Stock

2-38 - 3 pk rolled, 12 pcs. Open Stock

40067 - 6 pk rolled, 12 pcs. Open Stock

40069 - 10 pk bagged, 12 pcs. Open Stock

2-108 - 10 pk bagged, 12 pcs. Open Stock

40065D - 3 pk rolled, 36 pcs. Tray Pack

2-668 - 6 pk rolled, 6 pcs. Cut Case



Cotton Terry Towel (14" x 17")

- Dries and details
- Washable and reusable
- Hemmed for extra durability

3-5238 - 2 pk rolled, 24 pcs. Open Stock

40050 - 3 pk rolled, 12 pcs. Open Stock

3-6828 - 3 pk rolled, 24 pcs. Open Stock

40051 - 12 pk bagged, 6 pcs. Open Stock

3-685-58 - 12 pk PDQ, 10 pcs. Open Stock

3-5288 - 12 pk bagged, 12 pcs. Open Stock

3-5288-7 - 12 pk bagged, 12 pcs. Cut Case

45054 - 4 pk bagged, 12 pcs. Open Stock

3-5278 - 4 pk bagged, 12 pcs. Open Stock

40050D - 3 pk rolled, 30 pcs. Tray Pack

3-6848 - 6 pk rolled, 12 pcs. Open Stock

3-6848-7 - 6 pk, 12 pcs. Cut Case



Shop Towels (13" x 14")

- Washable and reusable general purpose use

40046 - 5 pk rolled, 12 pcs. Open Stock

3-591-158 - 5 pk Cut Case, 15 pcs. Cut Case

40047 - 10 pk rolled, 12 pcs. Open Stock

40048 - 25 pk bagged, 6 pcs. Open Stock

40046D - 5 pk rolled, 36 pcs. Tray Pack

3-5368 - 10 pk rolled, 24 pcs., Open Stock

3-5368-5 - 10 pk rolled, 12 pcs. Cut Case

3-5588 - 50 pk bagged, 8 pcs. Open Stock

3-5308 - 4 pk bagged, 24 pcs. Open Stock

3-5378 - 12 pk bagged, 20 pcs. Open Stock

3-5428 - 25 pk bagged, 6 pcs. Open Stock



Bag of Rags

- Soft, washable and absorbent
- Perfect for all purpose clean up
- Perfect for auto, home, marine and shop use

40071 - ½ lb, 6 pcs. Open Stock

40072 - 1 lb, 6 pcs. Open Stock

2-2548 - 1 lb, 6 pcs. Open Stock





TANNER'S SELECT®

Tanner's Select® chamois are Quality controlled from farm to retail shelf throughout the manufacturing and production process, tanned in Turkey and all made from the highest quality New Zealand sheepskin



Award Winning Packaging

PREMIUM QUALITY, LASTING VALUE

All Tanner's Select® chamois are electronically measured before being packaged to ensure the proper sizing. Quality remains our primary focus throughout the production cycle to ensure that our final product is the finest chamois available

- 125 years of tanning and supply management experience
- Unmatched program strategies that boost profits and bring customers back!

FROM SHEEP TO SHELF THE TRUSTED CHOICE FOR CHAMOIS IN NORTH AMERICA

From Selected Sheep for the Finest Chamois Available



Tanner's Select® Naturel Chamois

- 100% all natural sheepskin chamois
- Superior tanning for extra absorbency

TS95T4 - 6.5 sq. ft., 4 pcs. Open Stock
TS90T6 - 6 sq. ft., 6 pcs. Open Stock
TS85T6 - 5.5 sq. ft., 6 pcs. Open Stock



Tanner's Select® Naturel Chamois

- 100% all natural sheepskin chamois
- Superior tanning for extra absorbency

TS80T6 - 5 sq. ft., 6 pcs. Open Stock
TS75T6 - 4.5 sq. ft., 6 pcs. Open Stock
TS70T6 - 4 sq. ft., 6 pcs. Open Stock



Tanner's Select® Naturel Chamois

- 100% all natural sheepskin chamois
- Superior tanning for extra absorbency
- Remove fingerprints and dust from dashes, windows, touchscreens, mirrors, appliances, TVs and more

TS60T6 - 3.5 sq. ft., 6 pcs. Open Stock
TS40T6 - 3 sq. ft., 6 pcs. Open Stock
TS20T6 - 2.5 sq. ft., 6 pcs. Open Stock
TS10T6 - 2 sq. ft., 6 pcs. Open Stock





TANNER'S SELECT®

LUXURY LEATHER CARE

Best Leather Care - Anywhere!

Tanner's Select® Leather Life products are simply the best choice to clean, condition, revive, and restore any leather item

Premium blends are specially formulated to gently and effectively clean and condition all types of leather. Our products help your leather goods maintain their flexibility and breathability over time; prolonging that factory-fresh look and feel!



Tanner's Select®
Leather Life
Ultimate Cleaner & Conditioner
Foaming Aerosol - 14 oz.

- Gently loosens and lifts dirt and debris
- Penetrates and hydrates as it cleans
- Leaves a clean, non-oily surface

45704 - 6 pcs. Open Stock

Auto • Home • Apparel • Accessories • On the Go





CAR DUSTERS™

Dust Off Idling Sales with a Brand that Shines



Pacific Coast™ Professional Car Duster

- Specially treated fibers lift dust and dirt, will not scratch paint
- Long handle for added reach
- Storage bag included

93007 - 6 pcs. Open Stock

93008PC - 6 pcs. With wood handle, Open Stock



Pacific Coast™ Dash Duster

- Specially treated fibers lift dust and dirt, will not scratch paint
- Use for auto, home and more
- Safe on all surfaces

93006 - 6 pcs. Open Stock



Pacific Coast™ Drying Towel

- Premium synthetic towel in a reusable canister
- The easiest way to dry your vehicle
- Also great for household, marine and drying pets
- 3 Square feet

45218 - 6 pcs. Open Stock





#1 Name In Glass Care... Everywhere

Innovative Glass Care Accessories Make Each Cleaning Task Easier

Designed to handle all glass, mirror, and optical cleaning jobs for your car, truck, SUV or RV. Compact and convenient; use them at home, on the go, on their own or with your favorite Rain-X® cleaning liquids for a truly flawless result. With solutions for washing, drying, dusting, polishing and defogging, the Rain-X® Glass Cleaning and Care Accessory line

**Lets You See Clearly...
Inside & Out!**



Leverage Rain-X® brand equity to promote and cross-sell in your planogram



Rain-X® Liquid-Filled Window Wand™

- Triangle design pivots to reach corners
- Reversible bonnet cleans and defogs glass
- Easy to reach spray pump with 4 oz. bottle

9274X - 6 pcs. Open Stock
9275X - 6 pcs. Tray Pack



Twist-Lock Extension

Rain-X® 8" Squeegee with 39" Extension

- Flow-thru design reduces splash-back from bucket
- Integrated spot scrubbers
- Patented mesh locking feature adds durability

9271X - 6 pcs. Open Stock
9271XPDQ - 10 pcs. Tray Pack



Integrated Pump Sprayer

Rain-X® Liquid-Filled 8" Spray Squeegee

- Tough scrub netting
- Side mount scrubber
- Refillable, easy pump spray

9425CDX - 12 pcs. Tray Pack



Extends to 15"

Rain-X® Compact 8" Squeegee

- Handle extends to 15" and collapses to store
- Compact design stores anywhere
- Double scrubbing action

9438X - 8 pcs. Tray Pack



Integrated Grip

Rain-X® Premium 8" Squeegee with 20" Handle

- Patented "double-wrap" scrub assist netting
- Patented mesh locking system has greater pull, prolonging product life
- Exclusive Water-Shed™ head design minimizes splash back and reduces fatigue

9272X - 6 pcs. Open Stock
9272XPDQ - 12 pcs. Tray Pack
800-524-1458



Swiper

**DRIES
EVERYTHING
FASTER!**

**Streak-Free Drying, Safe on all Surfaces
Auto, Truck, SUV, RV & Home**



Swiper

Swiper GO! Synthetic Chamois™

- 2-sided
- Streak-free drying
- Safe on all surfaces

45222X - 6 pcs. Open Stock



Swiper

Swiper Pro Ultimate Towel™

- Swiper-Matrix™ microfiber absorbs water from all sides
- Dries and polishes at the same time
- No streaks, spots or scratches
- 3.5 square feet

45225X - 12 pcs. Open Stock



Swiper

Swiper Blade Auto Drying Tool™

- Integrated soft silicone V-blade dries large areas fast
- Detail drying with microfiber bonnet
- Patented 2-sided hybrid drying blade

96012X - 4 pcs. Open Stock



Swiper

Swiper Synthetic Chamois™

- 2-sided towel and sponge
- Streak-free drying
- Safe on all surfaces
- 3 square feet

45223X - 6 pcs. Open Stock

45223XPDQ - 6 pcs. Tray Pack

Integrated
Scrubbing Dots



Rain-X® 3-in-1 Window Blade™

- Premium terry microfiber removes fingerprints and window haze
- Soft suede microfiber cleaning with scrub dots
- Sof-Tools™ flexible squeegee quickly removes morning mist and dries all exterior windows

45619X - 6 pcs. Open Stock



Rain-X® Triple Blade Glass Tool™

- Removes bugs and debris
- Swipes clean wiper blades
- Lifts labels and decals
- Works on all glass, mirror, and optical cleaning jobs

45544X - 12 pcs. Tray Pack



Bliss® 2 pc Microfiber & Dash Detailing Pads™

- 2-sided for more cleaning flexibility
- Sewn pockets for added control
- Perfect for quick touch ups on glass & mirrors
- Lint-free - safe on all surfaces

45089X - 6 pcs. Open Stock



Rain-X® 2-Sided Microfiber Defogger Sponge

- Compact microfiber sponge is ideal for quick dash cleaning and window defogging
- Blue terry microfiber quickly cleans glass screen & optical surfaces
- Yellow, soft suede microfiber removes fingerprints and window haze

45116X - 6 pcs. Tray Pack



Rain-X® Microfiber Fog Ball

- Defogs and cleans glass and mirror surfaces
- Premium microfiber chenille
- Works on all glass, mirror and optical cleaning jobs

45078X - 12 pcs. Tray Pack



Rain-X® 2-Sided Bug & Tar Sponge

- Gray, heavy mesh is ideal for body, bumper, and wheel scrubbing
- Blue mesh works great on glass, headlights, and optics

45122X - 6 pcs. Tray Pack

QUALITY GLASS CARE TOOLS



The most comprehensive assortment of glass care tools available and the #1 position in North America



2 Gallon Squeegee Bucket with Steel Bracket (Black)

- Sturdy molded plastic
- Ideal for service station island

885 - 1 pc.



1 Gallon Squeegee Bucket with Steel Bracket (Black)

- Sturdy molded plastic
- Ideal for service station island

94101 - 18 pcs.



6" Squeegee

- 6" soft rubber squeegee
- Flexible high quality silicone blade
- Clear coat safe & stores flat

4-5038 - 12 pcs. Open Stock



6" Red Plastic Head with 9" Handle

- Heavy-duty plastic handle with rubber blade
- Foam with scrub netting

806NY - 6 pcs. Open Stock



"Misty" 6" Acrylic Plastic Squeegee with Netting

- Heavy-duty plastic handle with rubber blade
- Foam with scrub netting

9020A - 24 pcs. Open Stock



10" Professional Metal Squeegee with Extendable Pole

- Rust resistant, EPDM pliable blade, bug scrub netting
- Plastic side guards protects glass
- Adjustable handle

Multiple Parts

Brand	Part #	Description
Mallory	4-10NY-E	10" professional squeegee head with 49"- 7' aluminum telescopic handle (unassembled), 4 pk
Carrand	9500	10" squeegee with 48"- 7' extendable handle (assembled), 6 pk



8" Professional Metal Squeegee with Extendable Pole

- Rust resistant, EPDM pliable blade, bug scrub netting
- Plastic side guards protects glass
- Adjustable handle

Multiple Parts

Brand	Part #	Description
Mallory	8NYE-48	8" pro squeegee head with 48" aluminum telescopic handle, 12 pk
Carrand	9045RA	8" squeegee with 36" extendable handle (steel), 24 pk
Carrand	9049	8" deluxe squeegee with 36" extendable handle (steel), 24 pk





Deluxe 8" Professional Metal Head with Wood Handle (assembled)

- Rust resistant, pliable blade, bug scrub netting
- Plastic side guards protects glass

Multiple Parts

Brand	Part #	Description
Mallory	8NY-16A	8" pro squeegee head with 12" handle, red, 24 pk
Mallory	8NY-24A	8" pro squeegee head with 20" handle, red, 12 pk
Mallory	24-808NY-30A	8" pro squeegee head with 30" handle, red, 24 pk
Carrand	9031R	8" squeegee with 12" handle, red, 24 pk
Carrand	9032R	8" squeegee with 20" handle, red, 24 pk
Carrand	9047R	8" squeegee with 32" handle, red, 24 pk
Carrand	9057	8" deluxe squeegee with 20" handle, black, 24 pk



Deluxe 10" Professional Metal Head with Wood Handle (assembled)

- Rust resistant, pliable blade, bug scrub netting
- Plastic side guards protects glass

Multiple Parts

Brand	Part #	Description
Mallory	10NY-24A	10" pro squeegee head with 20" handle, red, 12 pk
Carrand	9037R	10" squeegee with 20" handle, red, 24 pk
Carrand	9058	10" deluxe squeegee with 20" handle, black, 24 pk



Deluxe 8" Professional Plastic Squeegee with Extendable Handle (assembled)

- EPDM Blade, nylon net, heavy-duty sponge
- Adjustable handle

Multiple Parts

Brand	Part #	Description
Mallory	WSE-39A	8" pro squeegee head with 24"- 39" aluminum extendable handle, 8 pk
Carrand	9046	8" plastic head with 21"- 36" extendable steel handle, 24 pk
Carrand	63148	8" snap & store squeegee with extendable aluminum handle



Deluxe 8" Professional Plastic Squeegee with Solid Plastic Handle (assembled)

- EPDM Blade, nylon net, heavy-duty sponge
- Perma-net locking system; Double wrap netting

Multiple Parts

Brand	Part #	Description
Mallory	WS1524A	8" pro squeegee head with 15" handle, 24 pk
Mallory	WS2024A	8" pro squeegee head with 20" handle, 24 pk
Carrand	9266	8" squeegee head with 15" handle, 24 pk
Carrand	9267A	8" squeegee head with 20" handle, 24 pk

UNASSEMBLED SQUEEGEE

Deluxe Metal Professional

Brand	Part #	Description
Mallory	12-8NY-48	8" pro squeegee with 48" hardwood handle, 12 pk
Mallory	4-10NY-E	10" pro squeegee with 7' aluminum telescopic handle, 4 pk
Carrand	9010R	8" metal head with 20" wood handle, red, 12 pk
Carrand	9014R	8" metal head with 12" wood handle, red, 12 pk
Carrand	9039R	10" deluxe metal head with 20" wood handle, red, 12 pk
Carrand	9053	8" deluxe steel head with 20" wood handle, black, 12 pk



Deluxe Plastic Professional

Mallory	WS1524U	8" pro head, 15" plastic handle, 24 pk
Mallory	WS2024U	8" head, 20" plastic handle, 24 pk
Mallory	WS4224U	8" head, 42" aluminum handle, 24 pk
Carrand	9262B	8" head with 15" plastic handle in sealed bag, "Professional Squeegee in a Bag", 12 pk
Carrand	9263	8" plastic head with 20" plastic handle, 12 pk

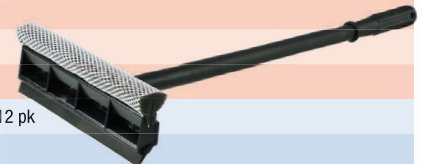

BULK SQUEEGEE HEADS

Metal (Steel) Professional

Brand	Part #	Description
Mallory	12-808NYU	8" professional squeegee head
Mallory	12-810NYU	10" professional squeegee head
Carrand	9000R	8" metal head
Carrand	9033R	10" metal head
Carrand	9050	8" deluxe squeegee head
Carrand	9051	10" deluxe squeegee head

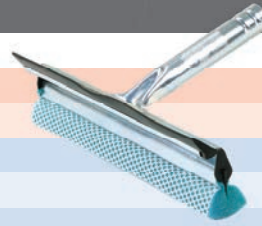

Plastic Professional

Mallory	WSH24	8" professional plastic head, black
Carrand	9260	8" plastic head, black

BULK SQUEEGEE HANDLES

Brand	Part #	Description
Mallory	110U	12" professional threaded hardwood handle, black
Mallory	111U	20" professional threaded hardwood handle, red
Mallory	112U	30" professional threaded hardwood handle, red
Mallory	148	48" professional hardwood handle
Mallory	WS1524	15" professional solid, heavy-duty, plastic handle, black
Mallory	WS2024	20" professional solid, heavy-duty, plastic handle, black
Mallory	WS4212	42" professional heavy-duty, aluminum handle
Carrand	9003R	12" wood handle, red
Carrand	9005R	20" wood handle, red
Carrand	9007R	32" wood handle, red
Carrand	9008BLK	20" wood handle, black
Carrand	9217Blk	15" plastic handle, black
Carrand	9221Blk	20" plastic handle, black

**FIBERGLASS, METAL, WOOD HANDLES - BULK**

Brand	Part #	Description
Mallory	160	60" professional threaded hardwood handle - natural finish
Mallory	118-54	54" professional threaded aluminum handle with grip
Carrand	92508	4-8 ft. fiberglass extension pole with metal tip - non flow-thru
Carrand	92509	6-12 ft. fiberglass extension pole with metal tip - non flow-thru
Carrand	92510	6 ft. fiberglass pole with (15/16") metal tip - non flow-thru
Carrand	92511	5-10 ft. fiberglass extension pole with metal tip - non flow-thru
Carrand	93069	60" handle with (15/16") metal tip, acme thread, steel - non flow-thru
Carrand	93501	60" handle, 1" diameter wood pole sanded, tapered, threaded - non flow-thru
Carrand	93502	72" handle, 1-1/8" diameter wood pole with metal tip, acme thread - non flow-thru
Carrand	93504	60" handle, 1" diameter wood pole with thread, lacquered - non flow-thru
Carrand	9501	48"- 84" aluminum extension handle - non flow-thru
Carrand	9507	53"- 96" aluminum extension handle with reinforced tip - non flow-thru
Carrand	9508	27"- 48" steel non flow-thru extension handle with reinforced tip, black powder coat
Carrand	9514	67" heavy-duty aluminum flow-thru extension handle with slide water control, (up to 67")



MERCHANDISING MENU

TRAY PACKS

Part #	Description	# Pcs.
40046D	5 pk Shop Towels (13" x 14")	36 pcs.
40050D	3 pk Cotton Terry Towels (14" x 17")	30 pcs.
40061D	3 pk Microfiber Towels (12" x 16")	25 pcs.
40062D	8 pk Microfiber Towels (12" x 16")	12 pcs.
40065D	3 pk Diaper Soft Polishing Cloths (11" x 17")	36 pcs.
45078X	Microfiber Window Mate	12 pcs.
45116X	2-Sided Microfiber Defogger Sponge	6 pcs.
45544X	Triple Blade Glass Tool	12 pcs.
45625AS	6 pk Spa-Soft Detailing towels	12 pcs.
9025CDF	Window Wash Spray Squeegee	12 pcs.
9275X	Liquid-Filled Window Wand™	6 pcs.
9425CDX	Liquid-Filled 8" Spray Squeegee	12 pcs.
9438X	8" Compact Squeegee	8 pcs.
90072	Sweeper Nozzle	24 pcs.
45122X	2-Sided Bug & Tar Sponge	6 pcs.



OFF SHELF

Part #	Description	# Pcs.
92043WR	Contour Tire Wipe with Wire Basket	12 pcs.
92046WR	Interior/Exterior Detail Brush with Wire Basket	24 pcs.
92047WR	Finger Loop Scrub Brush with Wire Basket	12 pcs.



FLOOR DISPLAYS

Part #	Description	# Pcs.
93053D	8" Wash Brush with 48" Handle	12 pcs.
93058D	10" Wash Brush with 48" Handle	12 pcs.
93060D	8" Bi-Level Wash Brush with 48" Pole	12 pcs.
93062D	10" Wash Brush Extends to 65"	12 pcs.
93089D	10" Wash Brush Extends to 68"	12 pcs.
93097D	10" Bi-Level Wash Brush Extends to 71"	12 pcs.



INNOVATIVE TIRE REPAIR SOLUTIONS



DRIVING SAFETY AND PROTECTION FOR OVER 68 YEARS

TIRE SAFETY

GAME CHANGING INNOVATION

The innovation journey spawned from our unquenchable desire to delight the consumer. We listened to your shoppers and walked in their shoes to identify unmet needs. We re-imagined products, creating “new to the world” solutions that improve the tire safety product use experience

TURN-KEY ASSORTMENT

Different shoppers have different needs, so we created a broad portfolio with a logical progression of features. Therefore, your shopper gets a wide range of industry leading, value-added solutions tailored to their specific needs. And you can implement an integrated retail strategy to cross-promote and step up your shopper that will raise the growth trajectory for your business

RECOGNIZED BRAND

Whether your core shopper lives in the city or in the heartland of America, we have the brand for you. Genuine Victor™ has 69 years of tire safety experience and a unique heritage with a strong, loyal following

GENUINE
VICTOR™

- Trusted Tire Repair Brand
- Solutions for Every Need
- A Simpler and Better Shopping Experience

69 YEARS YOUNG, ALWAYS ORIGINAL



TIRE ACCESSORIES



TIRE REPAIR



INFLATION



GENUINE VICTOR™ TIRE SAFETY

VALVE THRU FORMULA TIRE SEALANT

ADVANCED NANO
TECHNOLOGY

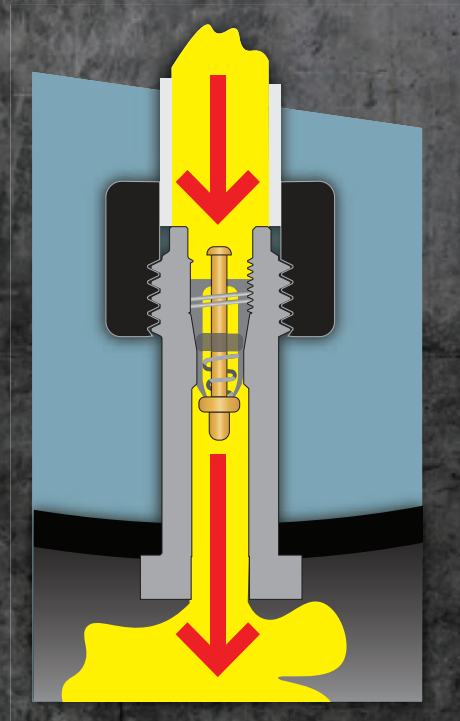

QuickFIX™ 12 oz. Refill Bottle

- Designed only to work with QuickFIX™ Tire Repair Kit
 - Instantly seals tread punctures up to 1/4" diameter
 - Non-toxic, non-flammable
- 22-5-57120-8 - 6 pcs. Open Stock



Valve Thru Tire Sealant - 32 oz.

- For tubeless tires
 - Instantly seals tread punctures up to 1/4" diameter
- 22-5-57109-8 - 6 pcs. Open Stock



Valve Thru Tire Sealant - 16 oz.

- For tubeless tires
 - Instantly seals tread punctures up to 1/4" diameter
- 22-5-57107-8 - 6 pcs. Open Stock

SmartSTOP™ INFLATORS

Give Your Shoppers the Knowledge to Be Safe



- **SmartSTOP™ Technology**
 - Countdown timer estimates and displays remaining fill time for any size tire
 - Automatically shuts off at the selected pressure
 - Truly the knowledge to be safe
- **Performance Guaranteed**
Backed by a lifetime warranty
- **Logical Progression of Features**
Broad portfolio of inflators to meet various shopper needs

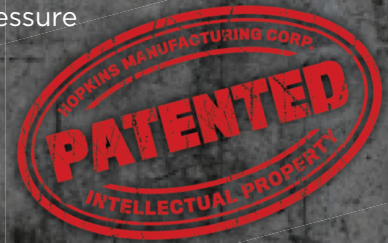

QuickDRIVE MAX™ Tire Inflator

- 1 Minute at 2100 cubic inches per minute*
- Digital, back-lit display for night time use
- Countdown timer displays remaining fill time

22-5-16055-8 - 2 pcs. Open Stock



QuickDRIVE™ Tire Inflator

- 1.5 Minutes at 1200 cubic inches per min.*
- Digital, back-lit display for night time use
- Countdown timer displays remaining fill time

22-5-16045-8 - 2 pcs. Open Stock



AutoSTOP ULTRA™ Tire Inflator

- 4 Minute fill time*
- Cordless & rechargeable
- Countdown timer displays remaining fill time

22-5-16070-8 - 2 pcs. Open Stock



AutoSTOP OUTDOOR™ Tire Inflator

- 5 Minute fill time*
- Fills your inflatables
- Countdown timer displays remaining fill time

22-5-16040-8 - 4 pcs. Open Stock



AutoSTOP™ Tire Inflator

- 5 Minute fill time*
- Digital, back-lit display for night time use
- Countdown timer displays remaining fill time

22-5-16030-8 - 4 pcs. Open Stock



Compact Tire Inflator

- 7 Minute fill time*
- LED work light
- Digital gauge

22-5-16020-8 - 4 pcs. Open Stock



Ultra Compact Tire Inflator

- 10 Minute fill time*
- LED work Light
- Analog dial gauge

22-5-16010-8 - 4 pcs. Open Stock

*Standard P195/65R15 Tires from 25-35 PSI



Hand Tire Pump

- 100 PSI capacity
- 21" Inflator hose
- Sport ball adapter kit

22-5-70008-8 - 6 pcs. Open Stock



Hand Tire Pump

- 70 PSI capacity
- 18" Inflator hose
- Quick release thumb lock valve

22-5-00088-8 - 12 pcs. Open Stock



Hand Pump - Max Air 7500MA

- 70 PSI capacity
- 21" Inflator hose
- Quick release thumb lock valve
- Ideal for auto, mowers, tractors, bicycles and more

7500MA - 12 pcs. Open Stock



Inflator Needles

- Use with sport balls and other inflatable products
- Metal construction
- 2 Standard inflation needles

22-5-70083-8 - 12 pcs. Open Stock

SmartTIP™ GAUGES

Other Gauges Don't Measure Up — Drive Sales With SmartTIP™ Technology

Only SmartTIP™ tire gauges engage inside the valve stem for a more secure, air-tight connection

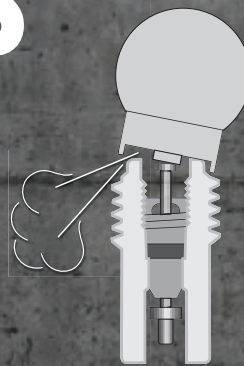

STANDARD TIPS

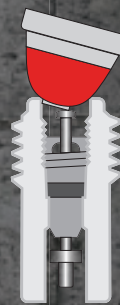

SmartTIP™



SmartTIP™ Digital Gauge with Bleeder Valve 0-150 PSI

- Attached bleeder valve
- Attached tread gauge to measure tread depth
- For all car, truck, SUV & RV tires

22-5-16140-8 - 6 pcs. Open Stock



SmartTIP™ Digital Gauge with Tread Gauge 0-150 PSI

- Work light
- Attached tread gauge to measure tread depth
- For all car, truck, SUV & RV tires

22-5-16130-8 - 6 pcs. Open Stock



SmartTIP™ Digital Gauge with Work Light 0-100 PSI

- Work light
- Back-lit display
- For all car, truck, SUV & RV tires
- **22-5-16120-8** - 6 pcs. Open Stock



SmartTIP™ Digital Gauge 0-100 PSI

- Back-lit display
- For all car, truck, SUV & RV tires
- **22-5-16110-8** - 6 pcs. Open Stock



SmartTIP™ Digital Tire Gauge 0-150 PSI

- For all car, truck, SUV, motorcycle & RV tires
- Back-lit display for easy-to-read tire pressure
- Chrome-plated steel body

22-5-70927-8 - 6 pcs. Open Stock



Dual SmartTIP™ Tire Gauge 10-120 PSI

- For all car, truck, SUV, motorcycle & RV tires
- Dual foot chuck
- High pressure

22-5-70926-8 - 6 pcs. Open Stock



SmartTIP™ Tire Gauge 10-50 PSI

- For vehicle tires & low pressure applications
- Chrome-plated steel body
- Two-sided indicator bar

22-5-70925-8 - 6 pcs. Open Stock

GROW YOUR BUSINESS WITH A FAMILY THAT'S WELL CONNECTED

- **SmartTIP™ Technology**
Engages inside the valve core
- **Better Connections**
Gives 15° of flexibility for a more secure air-tight connection
- **Features for Everyone**
Pencil, digital or back-lit display, our family can meet your shoppers every need





Digital Tire Inflation Air Gun

- 0-150 PSI pressure range with blue backlit display
- For use with air tanks or compressors
- Quick connect air chuck & built-in bleeder valve
- (2) "AAA" batteries included

22-5-70525-8 - 6 pcs. Open Stock



Digital Pressure Gauge with Lighted Display

- 5-99 PSI pressure range
- Built-in tire depth gauge
- Back-lit display

22-5-70003-8 - 6 pcs. Open Stock



Digital Pressure Gauge with Lighted Display

- 5-99 PSI pressure range
- Back-lit display
- Ergonomic design

22-5-60104-8 - 6 pcs. Open Stock



Digital Pencil Pressure Gauge

- 5-99 PSI pressure range
- Back-lit display
- Bar and PSI settings

22-5-60012-8 - 6 pcs. Open Stock



SUV/RV Dial Pressure Gauge

- 5-75 PSI pressure range
- Hose, dual foot and bleeder valve

22-5-70874-8 - 6 pcs. Open Stock



Pro Dial Pressure Gauge

- 5-100 PSI pressure range
- Hose and bleeder valve

22-5-70108-8 - 6 pcs. Open Stock



Pro Dial Pressure Gauge

- 5-60 PSI pressure range
- Bleeder valve

22-5-70881-8 - 4 pcs. Open Stock



Mini Dial Pressure Gauge

- 5-60 PSI pressure range
- Bleeder valve
- Carry case

22-5-70023-8 - 6 pcs. Open Stock



Mini Dial Pressure Gauge

- 5-60 PSI pressure range
- Metal construction
- Convenient to store

22-5-08770-8 - 6 pcs. Open Stock



Dial Pressure Gauge

- 10-60 PSI pressure range
- Bleeder valve

22-5-00890-8 - 6 pcs. Open Stock



Dial Pressure Gauge

- 10-100 PSI pressure range
- Bleeder valve

22-5-00897-8 - 6 pcs. Open Stock



Mini Dial Pressure Gauge - Tread/Magnet

- 5-60 PSI pressure range
 - Convenient to store
 - Includes magnet
- 22-5-60190-8** - 12 pcs. Open Stock - Bulk



Mini Dial Pressure Gauge - Magnet

- 5-60 PSI pressure range
 - Convenient to store
 - Includes magnet
- 22-5-60195-8** - 12 pcs. Open Stock - Bulk



Mini Dial Pressure Gauge - Tread

- 5-60 PSI pressure range
 - Sure grip rubber tread over-mold
 - Convenient to store
- 22-5-60090-8** - 12 pcs. Open Stock - Bulk



Digital Pocket Pressure Gauge - Square

- 0-99 PSI pressure range
 - Accurate reading
 - Convenient to store
- 22-5-84043-8** - 3 pcs. Open Stock - Bulk



Digital Pocket Pressure Gauge - Triangle

- 0-99 PSI pressure range
 - Accurate reading
 - Convenient to store
- 22-5-84042-8** - 3 pcs. Open Stock - Bulk



Digital Pressure Gauge - Sport

- 5-99 PSI pressure range
 - Accurate reading
 - Rubberized grip
 - Back-lit display and tip
- 22-5-60096-8** - 6 pcs. Open Stock - Bulk



Truck Long Dual Foot Pencil Pressure Gauge - Black

- 10-150 PSI pressure range
 - 4-Sided metal indicator bar
 - Lanyard ring included
- 22-5-71106-8** - 6 pcs. Open Stock



Truck Long Dual Foot Pencil Pressure Gauge - Chrome

- 10-150 PSI pressure range
 - 2-Sided indicator bar
 - Lanyard ring included
- 22-5-00889-8** - 6 pcs. Open Stock



Truck Short Dual Foot Pencil Pressure Gauge - Black

- 10-120 PSI pressure range
 - (4) Black plastic valve caps
 - 4-Sided indicator bar
- 22-5-60105-8** - 6 pcs. Open Stock



Straight Truck Tire Gauge

- 10-150 PSI pressure range
 - 12-3/8" long stem
 - Dual head for difficult to reach valves
- 22-5-71110-8** - 6 pcs. Open Stock



Dual Foot Pencil Pressure Gauge – Chrome

- 10-120 PSI pressure range
- (4) Black plastic valve caps
- 4-Sided indicator bar

22-5-00896-8 - 6 pcs. Open Stock



Heavy-duty Pencil Pressure Gauge

- 20-120 PSI pressure range
- 4-Sided indicator bar
- High pressure

22-5-00895-8 - 6 pcs. Open Stock



Standard Pencil Pressure Gauge

- 10-100 PSI pressure range
- 2-Sided indicator bar
- Pocket clip

22-5-00900-8 - 6 pcs. Open Stock



Deluxe Pencil Pressure Gauge

- 10-50 PSI pressure range
- 4-Sided indicator bar

22-5-00894-8 - 6 pcs. Open Stock



Stainless Steel Pencil Pressure Gauge

- 10-50 PSI pressure range
- (4) Black plastic valve caps
- 4-Sided indicator bar

22-5-00876-8 - 6 pcs. Open Stock



Standard Pencil Pressure Gauge

- 5-50 PSI pressure range
- 2-Sided indicator bar
- Chrome plated steel body

22-5-70902-8 - 6 pcs. Open Stock



Low Pressure Pencil Pressure Gauge

- 1-20 PSI pressure range
- 4-Sided indicator bar
- Pocket-clip

22-5-00887-8 - 6 pcs. Open Stock



Dual Foot Pencil Pressure Gauge

- 10-120 PSI pressure range
- 4-Sided indicator bar
- High pressure
- Pocket clip

22-5-60087-8 - 12 pcs. Open Stock - Bulk



Standard Pencil Pressure Gauge

- 10-50 PSI pressure range
- 2-Sided indicator bar
- Pocket clip

22-5-60084-8 - 12 pcs. Open Stock - Bulk



Mini Pencil Pressure Gauge - Magnet

- 10-50 PSI pressure range
- 4-sided indicator bar
- Includes magnet

22-5-60116-8M - 15 pcs. Open Stock - Bulk

SPEED PLUG™ TIRE REPAIR PLUGS

20X FASTER THAN TRADITIONAL TIRE STRING PLUGS



**FAST.
EASY.
CLEAN.**



ELIMINATES THE **AWFUL** WORK OF STRING PLUGS

Have you ever plugged a tire with traditional strings? It's a dirty, strenuous, awful job. Even the best pluggers take about 15 minutes to complete the task. Now you can do the same job 20 times faster with a Speed Plug™ by Genuine Victor™. Just screw it in and snap off the top. It's fast, easy and clean. Drive sales by eliminating the awful work of tire repair for your shoppers

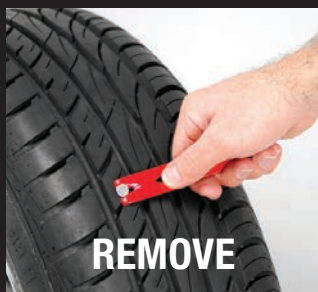

REMOVE

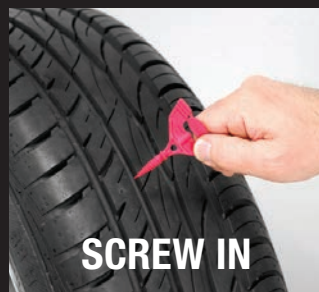

SCREW IN

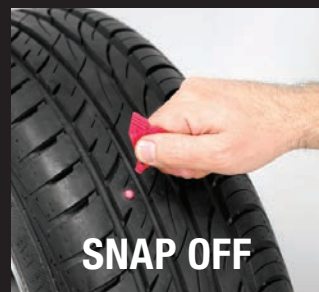

SNAP OFF



5 Piece Speed Plug Kit with Tool

- Eliminates the awful work of string plugs
- Up to 20x faster than traditional tire string plugs
- (4) Large plugs
- (1) Nail puller

22-5-70207-8 - 4 pcs. Open Stock

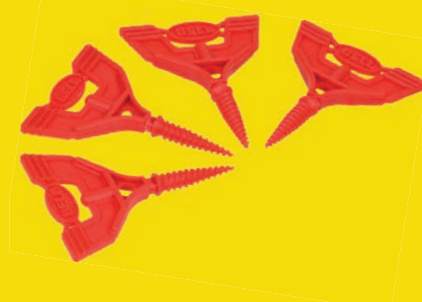

4 Piece Speed Plug Kit

- Eliminates the awful work of string plugs
- Up to 20x faster than traditional tire string plugs
- (4) Large plugs

22-5-70204-8 - 4 pcs. Open Stock

RepairKITS

Satisfy shoppers with complete tire repair solutions that have essential tools including patches, cement, plugs, and tools



13 Piece ATV Tire Repair Kit

- Complete ATV tire repair solution
- Convenient kit
- Dual tool ATV kit

22-5-70132-8 - 6 pcs. Open Stock



47 Piece Tire Maintenance Kit

- Deluxe complete tire repair solution in convenient storage case
- Tire toolbox
- Instruction booklet and carry case with handle

22-5-70126-8 - 6 pcs. Open Stock



32 Piece Tire Maintenance Kit

- Compact, complete tire repair solution in convenient storage case
- Deluxe tire tool box
- Gauge, tools, plugs and patches

22-5-70128-8 - 6 pcs. Open Stock



Truck 8 Piece Tubeless Tire Repair Kit

- Standard t-handle repair tools
- (5) 6" Heavy-duty tire plugs
- Rubber cement

22-5-00419-8A - 12 pcs. Open Stock



Pro 8 Piece Tubeless Tire Repair Kit

- Pro style pistol grip repair tools
- (5) 4" Standard plugs
- Pencil gauge

22-5-70110-8 - 6 pcs. Open Stock



Heavy-duty 7 Piece Tubeless Tire Repair Kit

- Standard t-handle repair tools
 - (5) Heavy-duty 4" plugs
- 22-5-70106-8** - 12 pcs. Open Stock



5 Piece Tubeless Tire Repair Kit

- Straight handle tire repair tools
 - (3) Standard 4" plugs
- 22-5-00104-8** - 6 pcs. Open Stock



8 Piece Tubeless Tire Repair Kit

- Split eye straight tire repair tool
 - (6) Plugs
 - Rubber cement
- 22-5-00101-8** - 6 pcs. Open Stock



8 Piece Tubeless Tire Repair Kit

- Split eye straight tire repair tool
 - (6) Plugs
 - Rubber cement
- 22-5-00103-8** - 6 pcs. Open Stock



8 Piece Tubeless Tire Repair Kit

- Split eye straight tire repair tool
 - (6) Vulca repair strips
 - Rubber cement
- 22-5-00108-8** - 12 pcs. Open Stock



5 Piece Tubeless Tire Repair Kit

- Split eye straight tire repair tool
 - (4) 6" Standard plugs
- 22-5-00102-8** - 12 pcs. Open Stock



100 Piece Patch Kit

- For all types of rubber repairs
 - (100) Assorted patches
 - Rubber cement
 - (2) Buffers
- 22-5-70184-8** - 6 pcs. Open Stock



33 Piece Tire and Rubber Patch Kit

- (29) Assorted patches
 - Rubber cement
 - Buffer
 - Storage can
- 22-5-00406-8A** - 12 pcs. Open Stock



15 Piece Tire Patch Kit – Mini-Can

- Includes (10) feather edge patches
 - Rubber cement
 - Tire pencil
 - Buffer
- 22-5-70407-8** - 12 pcs. Open Stock



8 Piece Patch Kit – EZ Fix Deluxe

- For all rubber repairs
- Patches
- Rubber cement
- Buffer

22-5-00401-8 - 12 pcs. Open Stock



5 Piece Patch Kit – Radial/Medium

- For heavy-duty repairs
- Patches
- Rubber cement
- Buffer

22-5-70414-8 - 12 pcs. Open Stock



7 Piece Patch Kit – Chemical/Round

- For all rubber repairs
- Patches
- Rubber cement
- Buffer

22-5-70405-8 - 12 pcs. Open Stock

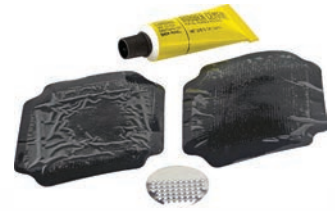

4 Piece Heavy-duty Patch Kit

- (2) Heavy-duty 2 7/8" x 3 5/8" patches
- Rubber cement
- Buffer

22-5-08826-8 - 6 pcs. Open Stock

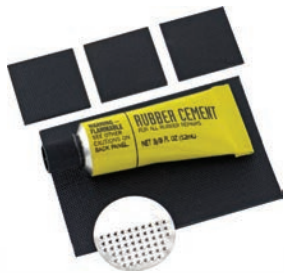

6 Piece Patch Kit – EZ Fix Bike

- For bicycle tire repairs
- Patches
- Rubber cement
- Buffer

22-5-00402-8 - 12 pcs. Open Stock



6 Piece Patch Kit – Super Thin

- (4) Patches
- Rubber cement
- Buffer

22-5-00410-8 - 12 pcs. Open Stock



30 Piece Black Plug Refills

- 4" Standard plugs
- Durable repair plugs
- For tubeless off-road tires

22-5-70111-8 - 4 pcs. Open Stock



5 Piece Black Plug Refills

- 7" Standard plugs
- Durable repair plugs
- For tubeless off-road tires

22-5-00420-8 - 12 pcs. Open Stock



5 Piece Brown Plug Refills

- 4" heavy-duty plugs
- Durable repair plugs
- For tubeless off-road tires

22-5-70112-8 - 12 pcs. Open Stock



5 Piece Black Plug Refills

- 4" Standard plugs
- Durable repair plugs
- For tubeless off-road tires

22-5-70105-8 - 6 pcs. Open Stock



Tube Rubber Cement – 1 oz. Tube

- For all rubber and tire repairs
- Universal formula
- Works great for patching

22-5-70600-8 - 12 pcs. Open Stock



ValveCAPS

Complete the look with an assortment of valve caps - Styles for every shopper



Valve Caps – Sport

- (4) Blue aluminum valve caps
 - Plastic thread insert
 - Protects your tire valve cores
- 22-5-70266-8** - 12 pcs. Open Stock



Valve Caps – Sport

- (4) Red aluminum valve caps
 - Plastic thread insert
 - Protects your tire valve cores
- 22-5-70265-8** - 12 pcs. Open Stock



Valve Caps – Sport

- (4) Black aluminum valve caps
 - Plastic thread insert
 - Protects your tire valve cores
- 22-5-70173-8** - 12 pcs. Open Stock



Valve Caps – Sport

- (4) Dark blue aluminum valve caps
 - Plastic thread insert
 - Protects your tire valve cores
- 22-5-70267-8** - 12 pcs. Open Stock



Valve Caps – Chrome Skulls

- (4) Chrome skull valve caps
 - Protects your tire valve cores
- 22-5-70851-8** - 12 pcs. Open Stock



Valve Caps & Sleeves – Chrome

- (4) Chrome valve caps and sleeves
 - Protects your tire valve cores
- 22-5-70722-8** - 12 pcs. Open Stock



Valve Caps – Chrome Hex

- (4) Chrome hex valve caps
 - Protects your tire valve cores
- 22-5-00716-8** - 12 pcs. Open Stock



Valve Caps – Slotted Head Chrome

- (4) Chrome valve caps
 - Caps include valve core tool
 - Protects your tire valve cores
- 22-5-00715-8** - 12 pcs. Open Stock



Valve Caps – Plastic (Nitrogen)

- (4) Chrome/green plastic valve caps
 - Replacement for old valve caps
 - Durable plastic
- 22-5-70721-8** - 12 pcs. Open Stock



Valve Caps – Plastic (Nitrogen)

- (4) Green plastic valve caps
 - Replacement for old valve caps
 - Durable plastic
- 22-5-00708-8** - 12 pcs. Open Stock



Valve Caps – Plastic

- (4) Chrome/plastic valve caps
 - Replacement for old valve caps
 - Durable plastic
- 22-5-70746-8** - 12 pcs. Open Stock



Valve Caps – Plastic

- (4) Gray plastic valve caps
 - Replacement for old valve caps
 - Durable plastic
- 22-5-70731-8** - 12 pcs. Open Stock



Valve Caps – Paw Prints

- (4) Aluminum valve caps
 - Plastic thread insert
 - Protects your tire valve cores
- 22-5-70747-8** - 12 pcs. Open Stock



Valve Caps – Black Hex

- (4) Aluminum valve caps
 - Black anodized finish
 - Protects your tire valve cores
- 22-5-70341-8** - 12 pcs. Open Stock



Valve Caps – Sport

- (4) Aluminum valve caps
 - Plastic thread insert
 - Protects your tire valve cores
- 22-5-70260-8** - 12 pcs. Open Stock



Valve Caps – Sport

- (4) Black aluminum valve caps
 - Plastic thread insert
 - Protects your tire valve cores
- 22-5-04150-M** - 6 pcs. Open Stock



Valve Caps – Plastic

- (4) Black plastic valve caps
 - Replacement for old valve caps
 - Durable plastic
- 22-5-70709-8** - 12 pcs. Open Stock



Valve Caps – TPMS Plastic

- (4) Black TPMS plastic valve caps
 - Replacement for old valve caps
 - Durable plastic
- 22-5-70707-8** - 12 pcs. Open Stock



Tire Valves – Metal

- 2 Pack
 - 1¼" Long
 - Bolt-in design
- 22-5-70410-8** - 6 pcs. Open Stock



TPMS Snap-in Tire Valve

- Single pack
 - Multi-purpose
 - Easy to install
- 22-5-70200-8** - 12 pcs. Open Stock



Tubeless Tire Valves – TR418

- 2 Pack
 - 2" Long
 - Snap-in design
- 22-5-70418-8** - 12 pcs. Open Stock



Tubeless Tire Valves – TR415

- 2 Pack
 - 1¼" Long
 - Snap-in design
- 22-5-70415-8** - 12 pcs. Open Stock



Tubeless Tire Valves – TR413

- 2 Pack
 - 1½" Long
 - Snap-in design
- 22-5-70413-8** - 12 pcs. Open Stock



Valve Extensions – Metal

- 4 Pack
 - 1¼" Long
- 22-5-70718-8** - 12 pcs. Open Stock



Valve Extensions – Plastic

- 4 Pack
 - 1½" Long
- 22-5-00713-8** - 12 pcs. Open Stock



Valve Extensions – Plastic

- 4 Pack
 - 1¼" Long
- 22-5-70712-8** - 12 pcs. Open Stock



Valve Extensions – Plastic

- 4 Pack
 - ¾" Long
- 22-5-00711-V** - 12 pcs. Open Stock



Valve Core Torque Tool

- Eliminates leaky valves and avoids false readings
 - Twist torque feature prevents over or under tightening
 - Keeps TPMS fully operational
- 22-5-71939-8** - 12 pcs. Open Stock



Tire Crayon

- White tire marker
 - Mark tire repair locations
 - Touch up whitewall and tire lettering
- 22-5-60181-8** - 6 pcs. Open Stock



Tire Tread Depth Gauge

- Chrome with pocket clip
 - Tire tool
 - Ensure safe driving
- 22-5-70174-8** - 6 pcs. Open Stock



4-Way Valve Tool – Valve Cores

- 5 Pack
 - 4-Way valve tool
 - (4) Standard valve cores
- 22-5-70141-8** - 12 pcs. Open Stock



Valve Tool – 4-Way

- Single pack
 - 4-Way valve tool
- 22-5-00714-8** - 12 pcs. Open Stock



Valve Cores – Short

- 4 Pack
 - Standard valve cores
- 22-5-00710-8** - 12 pcs. Open Stock

A high-angle, close-up photograph of a car's interior. The steering wheel is in the foreground, featuring a black leather-like finish with silver accents and various control buttons. The dashboard and center console are visible in the background, showing a gear shifter and handbrake. The seats are black with red stitching. The overall lighting is dim, highlighting the textures and materials of the car's interior.

COMFORT & ORGANIZATION WITH QUALITY & INNOVATION

PREMIUM ACCESSORIES FOR
PROTECTION AND CONVENIENCE

SUPERIOR TECHNOLOGY

Delivering performance has been our passion for decades and we continue to develop pioneering innovation to improve the consumer experience

DESIGNS FOR EVERY STYLE

Different shoppers appreciate different styles. That's why we've combined forward fashion with scientific method to develop a broad, impactful portfolio that will optimize your shelf and drive greater sales

BRANDS THAT RESONATE

Some people explore the outdoors, some explore the sights of the city. Wherever an adventure takes your shopper, we have the brand for them. From Bell[®], blue-collared ambition to GoGear[™] practicality; from the active Body Glove[®] lifestyle to the energy of the car enthusiast with Hoonigan; we have the brands that your shoppers know and love



BODY GLOVE

[HOONIGAN]

GO GEAR[®]

DBA[™]
DavidGonzalesArt

MOSSY OAK[®]



BODY GLOVE

CREATE HAPPINESS

In 1953 twins Bill and Bob Meistrell designed the first practical neoprene wetsuit in a pool in Boonville, Missouri, and Body Glove® was born. Since then Body Glove® has grown to be a leading lifestyle brand worldwide and successfully launched products across dozens of categories, from wetsuits to now vehicle accessories. Trusted as an active outdoor brand, customers can continue to enjoy Body Glove®'s innovation and quality in the comfort of their vehicles.



**Body Glove® 60/40
Bench SC 4PK**

22-1-70452-9 -
4 pcs. Open Stock

PROTECTION & CONVENIENCE





HYPERFIT™

Body Glove® Universal Bucket Seat Cover

- Water repellent
- Durable and comfortable neoprene

22-1-70359-9 - 4 pcs. Open Stock



Body Glove® Bench Seat Cover

- Water repellent
- Patented middle seat belt shoulder strap access panels

22-1-70395-9 - 4 pcs. Open Stock



HYPERFIT™

Body Glove® Seat Cover Kit

- Water repellent
- Patented middle seat belt shoulder strap access panels

22-1-70418-9 - 2 pcs. Open Stock



HYPERFIT™

Body Glove® Universal Bucket Seat Cover

- Officially licensed Body Glove® cool neoprene material

22-1-70331-9 - 4 pcs. Open Stock



HYPERFIT™

Body Glove® Universal Bucket Seat Cover - Smoothie

- Sleek and sporty Body Glove® seat cover
- Zig-zag stitching for style and durability

22-1-70231-9 - 4 pcs. Open Stock



Body Glove® Bench Seat Cover

- Officially licensed Body Glove® cool neoprene material
- Patented middle seat belt shoulder strap access panels

22-1-70332-9 - 4 pcs. Open Stock



HYPERFIT™

Body Glove® Universal Bucket Seat Cover - Red

- Sleek and sporty Body Glove® seat cover
- Zig-zag stitching for style and durability

22-1-70381-9 - 4 pcs. Open Stock



HYPERFIT™

Body Glove® Low-Back Bucket Seat Cover - Smoothie

- Sleek and sporty Body Glove® seat cover
- Zig-zag stitching for style and durability

22-1-70239-9 - 4 pcs. Open Stock



HYPERFIT™

Body Glove® Low-Back Bucket Seat Cover - Red

- Same great Body Glove® seat cover now with colored bolsters
- Zig-zag stitching for style and durability

22-1-70387-9 - 4 pcs. Open Stock



Body Glove® Smoothie Steering Wheel Cover

- Body Glove® steering wheel cover now with two-tone matte black
- Zig-zag stitching for style and durability

22-1-97505-9 - 6 pcs. Open Stock

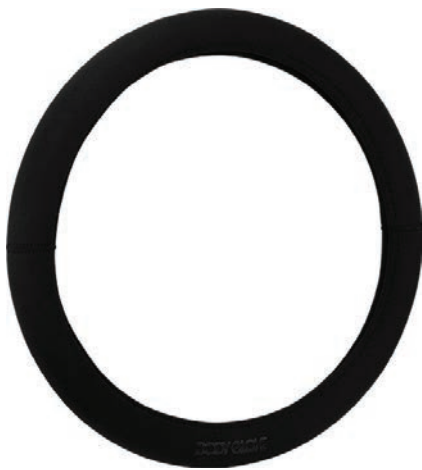

Body Glove® Steering Wheel Cover

- Officially licensed Body Glove® cool neoprene material

22-1-97443-9 - 6 pcs. Open Stock

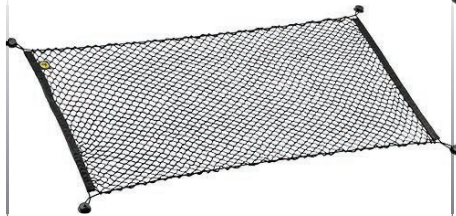

Body Glove® Cargo Net with Mounting Kit

- Ideal for the rear cargo areas of cars, vans, trucks & SUVs
- 45" x 24" size
- Cargo net stretches to 60"

22-1-70412-8 - 4 pcs. Open Stock



Body Glove® Seat Gap Net Organizer

- Pocketed hammock assembly secures items between front seats
- 12" x 11" size, stretches to 20"

22-1-70411-8 - 4 pcs. Open Stock





Body Glove® Visor Organizer

- Officially licensed Body Glove® cool neoprene material

22-1-70329-8 - 4 pcs. Open Stock



Body Glove® Magnetic Sunglass Case

- Visor mounted case
- Magnetic to remove/attach easily
- Includes hook for backpacks and more

22-1-70340-8 - 4 pcs. Open Stock



Body Glove Seatbelt Shoulder Pad

- Adds comfort and cushion to seatbelts, golf bags, luggage, backpacks, and more
- Awesome neoprene material for comfort and durability
- Just like a wetsuit!

22-1-70339-8 - 6 pcs. Open Stock



[HOONIGAN]

PURVEYORS OF FINE HOONAGE™



MEDIA REACH

55M+
INFLUENCER REACH

8.4M+
YOUTUBE SUBSCRIBERS

27.5M+
OVERALL REACH

NEW

Hoonigan Scatter Seat Cover

- Easy to Install and Remove
- Made from durable material
- Protect your seats while showing off your Hoonigan Style
- Fits most seats with adjustable headrests

22-1-73000-9 - 4 PCs, Open Stock



PROTECTION & CONVENIENCE



NEW

Hoonigan H Block Emblem

- High-quality material- Durable ABS plastic meant to last
- Easy to install- 3M adhesive allows this to be placed anywhere legally allowed

22-1-70025-8 - 6 PCs, Open Stock



NEW

Hoonigan Scatter Seat Belt Shoulder Pad

- Add comfort and cushion to seatbelts, golf bags, luggage, backpacks and more
- Durable material adds comfort built to last
- Easy installation with velcro to secure around seatbelts and bag straps

22-1-70019-8 - 6 PCs, Open Stock



NEW

Hoonigan Fuzzy Dice

- Add style to your vehicles interior
- Premium plush materials creates durability
- Hangs from rearview mirror

22-1-70022-8 - 6 PCs, Open Stock



NEW

Hoonigan Censor Bar Nylon Key Chain

- High-quality material- Zinc alloy and nylon materials create durability
- Easy to install- Key ring or claps allows quick installation

22-1-70033-8 - 100 PCs, Open Stock



NEW

Hoonigan Black Scatter License Plate Frame

- Universal designed fit - Fits most standard U.S. license plates
- Durable die-cast metal frame

22-1-46734-8 - 4 PCs, Open Stock



Hoonigan Black Bracket License Plate Frame

- Universal designed fit - Fits most standard U.S. license plates
- Durable die-cast metal frame

22-1-46733-8 - 4 PCs, Open Stock



Hoonigan Kill All Tires Flag Vinyl Decal

- Built tough with durable materials
- Easy to install
- Weatherproof and UV resistant

22-1-72023-8 - 96PCs, Open Stock



Hoonigan Vinyl Transfers

- Built tough with durable materials
- Easy to install
- Weatherproof and UV resistant

26" - 22-1-72020-8 - 96PCs, Open Stock

12" - 22-1-72021-8 - 96PCs, Open Stock



Hoonigan 10" Vinyl Decal

- Built tough with durable materials
- Easy to install
- Weatherproof and UV resistant

22-1-72022-8 - 96PCs, Open Stock

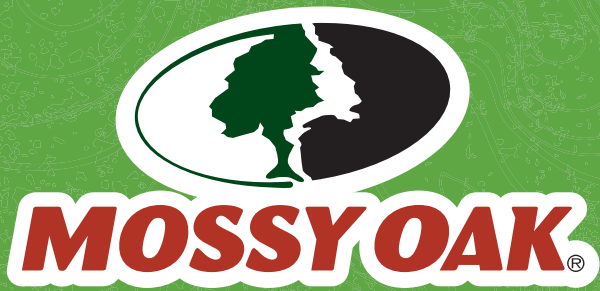

FUEL YOUR OBSESSION



Mossy Oak® started from a deep and abiding passion to connect with the Great Outdoors. Over the past 30-plus years, that passion has grown into an obsession to make more connections to wild critters and wild places while helping people live their best life outdoors. The line of Mossy Oak® seat covers are among the latest improvements from our workshop, with several features to help you ride in comfort and style.

PROTECTION & CONVENIENCE





Mossy Oak® Work Wear Black Seat Cover (Truck, 1-Piece)

- Specifically designed with trucks and large SUVs in mind for that full size fit
- Premium Padding – Interwoven luxury foam provides contoured fit and superior comfort
- Compatible with most side air bags to help maintain personal protection in your vehicle

22-1-70008-9 - 3 pcs. Open Stock



Mossy Oak® Work Wear Tan Seat Cover (Truck, 3-Piece)

- Specifically designed with trucks and large SUVs in mind for that full size fit
- Premium Padding – Interwoven luxury foam provides contoured fit and superior comfort
- Compatible with most side air bags to help maintain personal protection in your vehicle

22-1-70009-9 - 3 pcs. Open Stock



Mossy Oak® Large Organizer

- Hook and loop secures organizer in place and upright
- Convenient handle for organization on the go
- MOLLE panel for external storage

22-1-70013-8 - 12 pcs. Open Stock



Mossy Oak® Blackout Obsession Seat Cover (Sold as a Pair)

- Exclusive Mossy Oak® design subtly reflects your passion for the outdoors
- Compatible with most side air bags to help maintain personal protection in your vehicle

22-1-70007-9 - 4 pcs. Open Stock



HYPERFIT™ SEAT COVERS

LASTING. SNUG. FIT.

Upgrade your shoppers to consumer preferred HyperFit™ technology. Unlike loose straps that can't be tightened, the distinctive HyperFit™ Grip Lock system delivers 360° of form-fitting tension that won't bunch or stretch out over time, ensuring your seat cover will always have a tailored look. Give your shoppers a seat cover with a long-lasting, snug fit—HyperFit™

UNIVERSAL FIT. TAILORED LOOK. THE HYPERFIT™ DIFFERENCE.



COVER WITHOUT **HYPERFIT™**



HYPERFIT™



HYPERFIT™

Baja Blanket Bench Seat Cover

- Baja jacket inspired design
- 22-1-56259-8 - 1 pc. Open Stock



HYPERFIT™

Baja Blanket Universal Bucket Seat Cover

- Baja jacket inspired design
- 22-1-56258-9 - 4 pcs. Open Stock





HYPERFIT™

Indigenous Blanket Low-Back Bucket Seat Covers (Sold as a Pair)

- Tribal pattern woven durable blanket material

22-1-55508-9 - 4 pcs. Open Stock



HYPERFIT™

Mayan Mint Low-Back Bucket Seat Covers (Sold as a Pair)

- Mayan pattern woven durable blanket material

22-1-58051-9 - 4 pcs. Open Stock



HYPERFIT™

Gray Marle Low-Back Bucket Seat Cover (Sold as a Pair)

- Stylish and comfortable marle gray fabric bolstered on neoprene

22-1-58228-9 - 4 pcs. Open Stock



HYPERFIT™

Mayan Mint Low-Back Bucket Seat Cover

- Mayan pattern woven durable blanket material

22-1-58048-9 - 4 pcs. Open Stock



HYPERFIT™

Festival Aztec Low Back Seat Cover (Sold as a Pair)

- Colorful Aztec design on durable material

22-1-58103-9 - 4 pcs. Open Stock

Driving Authentic EXPRESSION



PROTECTION & CONVENIENCE



HYPERFIT™

All Terrain Black Universal Bucket Seat Cover

- Rugged and durable 600D nylon
- 22-1-55303-A - 1 pc. Open Stock



All Terrain Black Bench Seat Cover

- Rugged and durable 600D nylon
- 22-1-55302-A - 1 pc. Open Stock



Black Bench Seat Protector

- Protect seats from water, soda, coffee and more
- Easy and quick to install
- Durable material

22-1-70337-3 - 4 pcs. Open Stock
22-1-70337-8 - 4 pcs. Open Stock



Black Bucket Seat Protector

- Protect seats from water, soda, coffee and more
- Easy and quick to install
- Durable material

22-1-70336-8 - 4 pcs. Open Stock

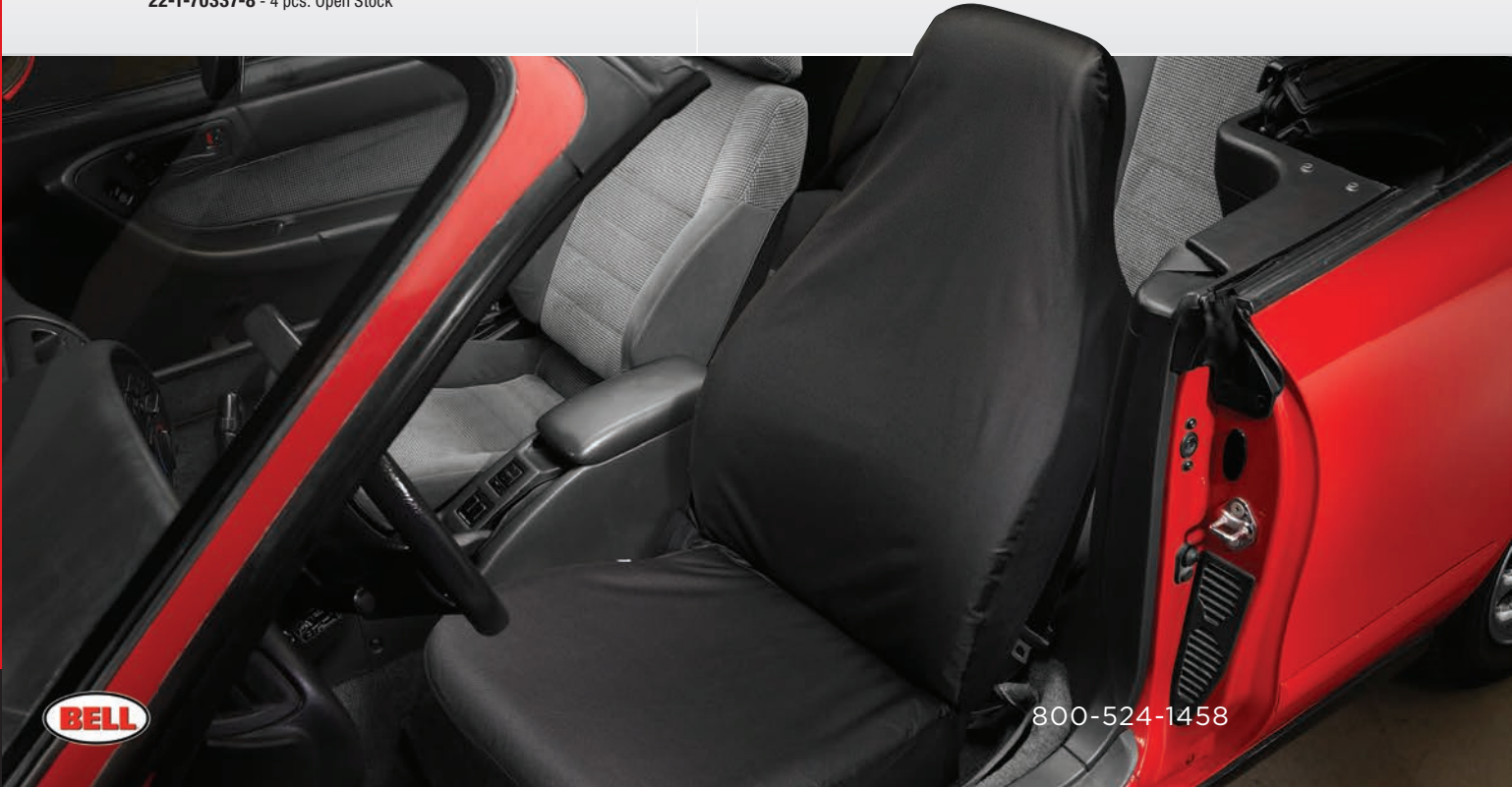

David Gonzales is one of the most influential artists of both car & bike culture. Now his designs can be enjoyed in your vehicle



DGA™ Bonita License Plate Frame

- Amazing printed graphics
- Includes many of the great DGA™ art pieces

22-1-46725-8 - 4 pcs. Open Stock



DGA™ Bonitas Steering Wheel Cover

- Amazing printed graphics
- Includes many of the great DGA™ art pieces

22-1-97653-924 - 24 pcs. Open Stock



HYPERFIT™

DGA™ Skin Deep Seat Cover

- Authentic licensed sublimated graphics on microfiber

22-1-70274-9 - 4 pcs. Open Stock



HYPERFIT™

DGA™ Ride or Die Seat Cover

- Authentic licensed sublimated graphics on microfiber

22-1-70296-9 - 4 pcs. Open Stock



HYPERFLEX CORE™

STEERING WHEEL COVERS



NEW Improved Core

- #1 Steering Wheel Cover Brand
- More Durable & Easier to Install

Than Standard Steering Wheel Covers

2X
EASIER
TO INSTALL
THAN STANDARD
STEERING WHEEL COVERS



STEERING WHEEL COVER BEST SELLERS



22-1-97660-9	Grey Fluffy	Faux grey fur with black accent for style and comfort
22-1-97658-9	Burlwood Grip	Ergonomic grip with burlwood pattern
22-1-97443-9	Body Glove® Black	Officially licensed Body Glove® neoprene material
22-1-97505-9	Body Glove® Smoothie	Two-tone matte black neoprene with zig-zag stitching
22-1-97657-9	Leopard Fluffy Thumbgrip	Contoured thumb grips with a faux fur for style and comfort



22-1-97487-924	Mayan Mint	Mayan pattern woven durable blanket material
22-1-97478-924	DGA Rose™	Easy Install HyperFlex Core™ that is odorless
22-1-97596-9	Fluffy Black	Soft faux fur for luxury, style and comfort
22-1-97654-9	Rainbow	Shimmery rainbow wrapped with leather
22-1-97659-9	Greywood Grip	Ergonomic grip with grey burlwood pattern



22-1-96126-9

22-1-97661-924

22-1-97653-924

22-1-97049-9

Part #	Product	Description
22-1-96126-9	Indigenous Blanket	Tribal inspired pattern on blanket material
22-1-97661-924	Festival Aztec	Stylish and colorful Aztec design
22-1-97653-924	DGA™ Bonitas	Includes many of the great DGA™ art pieces
22-1-97049-9	Moxie HyperFlex Core	Animal-inspired design
22-1-97006-9	Deluxe Burlwood Tan	Burlwood accents for a sporty look
22-1-97652-9	Silver Scale	Sleek and sporty silver scaled design
22-1-97315-9	Stripe Bling Black	Inset diamond accents with stripes
22-1-97037-9	Chicane	Sports performance inspired design



22-1-97006-9

22-1-97652-9

22-1-97315-9

22-1-97037-9



Part #	Product	Description
22-1-97655-9	Leopard Fluffy	Fuax fur for style and comfort
22-1-97023-9	Pleated Black	Classic look and design for added style
22-1-97313-9	Stratos	Classic two-tone design for added style
22-1-97651-9	Blue Contrast Quilted Grip	Blue diamond stitching for a stylish clean look
22-1-97656-9	Truck Tri Grip Tan 	Work wear styling with heavy-duty grip for trucks
22-1-97032-9	Fastline Black	Classic look and design with chrome piping
22-1-97029-9	Fine Stitch Black	Accent stitching for a stylish, clean look
22-1-97152-9	Blackwood Chrome	Faux-dark wood with chrome accents
22-1-97517-9	Phantom Red	Sleek and sporty accented design



LICENSE PLATE FRAMES

Protection, fun or fashion. Regardless of what drives your shopper, we have the solution for you. From simple to sassy, classic to creative, or fun to far out—Bell® has a wide assortment of license plate frames and fasteners to meet every need



Barbed Wire Black License Plate Frame

- The classic just got cooler...matte black
- 22-1-46565-8 - 2 pcs. Open Stock



Barbed Wire Chrome License Plate Frame

- Classic tough barbed wire design
- 22-1-46144-8 - 4 pcs. Open Stock



Mega Metal Chain Chrome License Plate Frame

- Classic metal chain to add style to any ride
- 22-1-46009-8 - 2 pcs. Open Stock



Chain Motorcycle License Plate Frame

- Molded plastic frame sized to fit motorcycles
- 22-1-46497-8 - 3 pcs. Open Stock



Silicone Bumper Black License Plate Frame

- Silicone frame for style and function
 - Prevents license plate rattle
- 22-1-46714-8 - 4 pcs. Open Stock



Spike License Plate Frame

- Cool and tough 3D spike design
- 22-1-46117-8 - 2 pcs. Open Stock





Bloom Baby License Plate Frame

- Tropical vibes for your car with a hot pink twist

22-1-46729-8 - 4 pcs. Open Stock



Leopard Print License Plate Frame

- Fashion forward, all-over leopard print design

22-1-46727-8 - 2 pcs. Open Stock



Geo Black License Plate Frame

- Die-cast metal frame is corrosion resistant
- Add a personalized finish to your vehicle exterior
- Protect your vehicle from natural wear and tear

22-1-46732-8 - 4 pcs. Open Stock

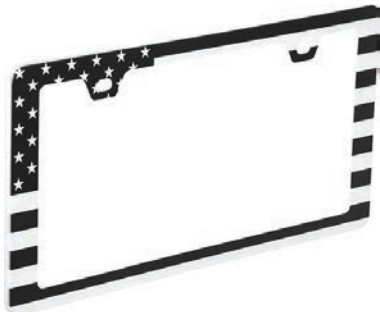

Black and White Flag License Plate Frame

- Bold, patriotic design

22-1-46724-8 - 4 pcs. Open Stock



Pawesome Chrome License Plate Frame

- Die-cast metal frame is corrosion resistant
- Add a personalized finish to your vehicle exterior
- Protects your vehicle from natural wear and tear

22-1-46731-8 - 4 pcs. Open Stock



Paw Prints License Plate Frame

- All over pattern because everyone loves their pets

22-1-46104-8 - 4 pcs. Open Stock



Bonitas License Plate Frame

- Amazing printed graphics
- Includes many of the great DGA™ art pieces

22-1-46725-8 - 4 pcs. Open Stock



Dealer Classic Chrome License Plate Frame

- Dealer classic for that clean look

22-1-46215-8 - 3 pcs. Open Stock



Diamonds Black License Plate Frame

- Diamonds are a girl's best friend

22-1-46501-8 - 2 pcs. Open Stock



INTERIOR ORGANIZATION & ACCESSORIES



22-1-33653-8

Enjoy Your Ride

Shoppers are spending more time in their vehicles—and driving more miles. Now, more than ever, they are looking for ways to organize their vehicle and make each ride more enjoyable. Provide your shoppers the latest solutions from our full line of organization and accessory products. From powering up mobile devices to storing different types of cargo, we have the right product for you.

PROTECTION & CONVENIENCE



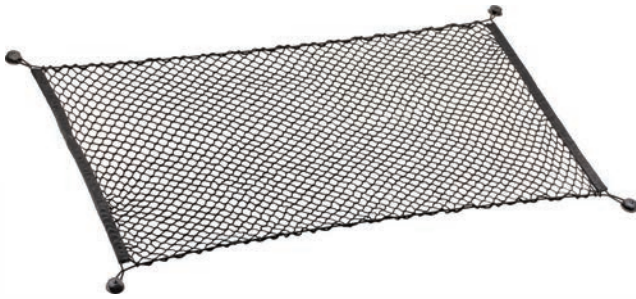

Cargo Net

- Ideal for the rear cargo areas of cars, vans, trucks & SUVs
- 45" x 24" size
- Cargo net stretches to 60"

22-1-33653-8 - 2 pcs. Open Stock



Console Plus Organizer™

- Unique mobile phone landing pad
- Multiple pockets and divided storage
- Magnetic lid keeps items out of view

CNSLPLUS-BLA - 3 pcs. Open Stock



Vent Pack Organizer™

- Durable netting allows you to see inside the organizer
- Adjustable clip fits almost any air vent
- Easy to move, simple to use

VENT-05 - 6 pcs. Open Stock, Clip Strip



Seat Console

- Designed to mount to floors, humps or seats
- Includes storage for CDs, pens and coins
- Two adjustable locking drink holders accommodate most size drinks

SC-BLA, SC-CHA - 2 pcs. Open Stock



Mini Console

- Designed for efficient storage and organization
- Storage for coins and CDs
- Two adjustable locking drink holders accommodate most size drinks

EMIC-BLA, EMIC-CHA - 3 pcs. Open Stock



Efficiency Console

- Economy console stores common travel items
- Storage for coins and CDs
- Two drink holders hold small to medium sized drinks

EFF-BLA, EFF-CHA - 5 pcs. Open Stock

GO GEAR



Visor Organizer™

- Storage space for smartphone
- All-purpose pocket and pen holder
- Durable Ny-Max™ material stands up to the toughest use and demands

VSR - 6 pcs. Open Stock

BELL



Visor Organizer™ Ostrich Black

- Classic design with faux ostrich material
- Fits most visors

22-1-33225-8 - 4 pcs. Open Stock

BELL



Seat Belt Clips

- Helps keep strap comfortably positioned
- Sold as a pair

22-1-33671-8 - 6 pcs. Open Stock

BELL



Deluxe Litter Bag

- Perfect for those little messes
- Includes 6 disposable liners
- Zippered bottom for easy access

22-1-00337-8A - 12 pcs. Open Stock

GO GEAR



Pop-Up Trash Can™

- Pops up to use, collapses down to store
- Treated liner helps contain spills and cleans easily
- Special tab on bottom keeps can from tipping and rolling

TRASH-BLA - 6 pcs. Clip Strip

GO GEAR



Space Saver Trash Can™

- Slim design utilizes vehicle space more efficiently
- Attaches to console, door, gear shift or seat pocket

TRASH10-BLA - 6 pcs. Open Stock

BELL



Deer Warnings Black

- Air flow activation
- Produces two separate, unique frequencies to help reduce vehicle animal collisions
- Adhesive mount included

22-1-01000-8 - 3 pcs. Open Stock

BELL



Deer Warnings Chrome

- Air flow activation
- Produces two separate, unique frequencies to help reduce vehicle animal collisions
- Adhesive mount included

22-1-01001-8 - 3 pcs. Open Stock

BELL



Octopus Drink Holder

- Self adjusting to fit many size drinks
- Non-slip base convenient for many different areas

22-1-00051-8 - 6 pcs. Open Stock

GO GEAR



Twin Cup Holder

- Includes two adjustable drink holders and a convenient personal organizer
- Unit mounts easily and securely to console, armrest or floor
- Console strap included

SMT - 6 pcs. Open Stock

BELL



Hula Doll

- Classic ornament for any ride
- Spring action hips
- Adhesive mount

22-1-36707-8 - 2 pcs. Open Stock

BELL



Ultra Clothes Bar

- Heavy duty oversized coated steel bars
- Dual mount hangers can be hung from vehicles
- Grab handles or clothes hooks
- Bar extends from 35-inches to 56-inches
- Cushioned no-slide bar

22-1-00073-8 - 2 pcs. Open Stock



**Butt Bucket Counter
6 Piece PDQ**

- Glow in the dark lid
 - Helps remove odor
 - Extinguish and store cigarette butts
- 22-5-00370-VP6 - 6 pcs. PDQ Tray



**Butt Bucket Counter
12 Piece PDQ**

- Helps remove odor
 - Extinguish and store cigarette butts
- 22-5-00370-VCT12 - 12 pcs. PDQ Tray



Carabiner Key Chain

- Conveniently store all your keys
 - Multiple different options- 3 carabiner sizes with 3 key rings
 - Durable and built to last
- 22-1-07249-8 - 3 pcs. Open Stock



Combo Clock/Compass/ Thermometer

- Lighted and mounts with hook & loop tape
 - Battery included
- 22-1-29015-8 - 2 pcs. Open Stock



Universal Mobile Device Holder

- Suction cup and air vent mounting
- 22-1-22235-8 - 2 pcs. Open Stock



Digital Clock

- Lighted, dash mount or stands upright
 - Displays hours, minutes, month and date
 - Battery included
- 22-1-37015-8 - 2 pcs. Open Stock



Ash Tray Aluminum

- Converts extra cup holder into functional ashtray
- Blue aluminum canister with chrome accent
- Easy to remove and clean

22-1-39264-8 - Blue, 2 pcs. Open Stock
 22-1-30230-8 - Black, 2 pcs. Open Stock
 22-1-39268-8 - Pink, 2 pcs. Open Stock



Dbe Outlet Lighter Adapter

- Adds an extra power source to your vehicle

22-5-05102-8 - 12 pcs. Open Stock



All Weather 12 Volt Power Socket

- Adds an extra power source to your vehicle

22-1-39052-8 - 2 pcs. Open Stock



Single Socket Battery Clip Power Adapter

- Power 12V devices directly from 12V battery

22-1-39011-8 - 2 pcs. Open Stock



Replacement 12 Volt Power Cord

- 8 Foot cord with fused 12V plug

22-1-39047-8 - 2 pcs. Open Stock



**KEEPING ROAD DEBRIS
WHERE IT BELONGS**

MUD AND SPLASH GUARDS

PROTECT YOUR RIDE

For DIY vehicle owners who enjoy the pride and confidence they feel from driving a vehicle that looks brand new, RoadSport™ Splash Guards provide high-quality, durable solutions to meet every need

FULL COVERAGE

No matter the vehicle or budget, RoadSport™ has a product to fit your shoppers' needs. Protect your ride or whatever you tow with peace of mind

THE BRAND SHOPPERS TRUST

The only brand of universal splash guards that provide an OEM look and fit. Made from unbreakable materials, RoadSport™ brand Splash Guards are built for the long haul





SCAN HERE FOR
A FULL VEHICLE
FITMENT LIST



PROTECT YOUR RIDE

For DIY vehicle owners who enjoy the pride and confidence they feel from driving a vehicle that looks brand new. RoadSport™ Splash Guards provide high-quality, durable solutions to meet every need. Designed with unbreakable materials with a broad assortment of sizes for cars, trucks, SUVs, trailers and RVs so drivers can keep their vehicle protected. The industry's largest assortments of universal fit splash guards.

MUD & SPLASH GUARDS

Truck/SUV

Splash Guards can handle the toughest street or off-road duty. Molded with a diamond-plate pattern, Truck/SUV Splash Guards provide protection and coverage for oversized wheels and tires. If you are fitting a fleet, work, off-road, farm or raised truck and need a mud guard that will protect and last, you need Truck/SUV Splash Guards



Large Truck/SUV Splash Guard

- Molded from a heavy-duty, unbreakable, flexible material
- Pre-marked mounting locations can be found on the rear of the splash guard
- Mounting hardware included

3102 - 4 pcs. Open Stock



X-Large Truck/SUV Splash Guard

- Molded from a heavy-duty, unbreakable, flexible material
- Pre-marked mounting locations can be found on the rear of the splash guard
- Mounting hardware included

3103 - 4 pcs. Open Stock



Extreme Truck/SUV Splash Guard

- Molded from a heavy-duty, unbreakable, flexible material
- Pre-marked mounting locations can be found on the rear of the splash guard
- Mounting hardware and stainless steel accents included

3105 - 4 pcs. Open Stock



Dually Truck/SUV Splash Guard

- Molded from a heavy-duty, unbreakable, flexible material
- Shaped for dual wheels
- Mounting hardware included

3104 - 4 pcs. Open Stock



Truck/SUV Stainless Steel Accent

- Rolled outer edges for safety and strength
- Works with model #3102, 3103, and 3104
- Easy way to accent and add extra flair to your splash guards
- Mounting hardware included

3101 - 6 pcs. Open Stock



Contour-Fit™

Provides full protection and enhanced styling to match the body lines of your vehicle for an OEM style with a universal fit. Eight profiles work with virtually all makes and models trucks, SUVs and cars



Contour-Fit™ Splash Guard Car 1

- Fits most compact passenger cars
- Custom look universal fit
- Large lip area conforms to fender flares and body panels
- Soft radii to follow body curves

6401 - 4 pcs. Open Stock



Contour-Fit Splash Guard Car 2

- Fits most mid-size passenger cars
- Custom look universal fit
- Large lip area conforms to fender flares and body panels
- Soft radii to follow body curves

6402 - 4 pcs. Open Stock



Contour-Fit Splash Guard Car 3

- Fits most intermediate size passenger cars
- Custom look universal fit
- Large lip area conforms to fender flares and body panels
- Soft radii to follow body curves

6403 - 4 pcs. Open Stock



Contour-Fit Splash Guard Car 4

- Fits most full-size passenger cars and small SUVs/CUVs
- Custom look universal fit
- Large lip area conforms to fender flares and body panels
- Soft radii to follow body curves

6404 - 4 pcs. Open Stock



Contour-Fit Splash Guard Truck 6

- Fits most light-duty trucks
- Custom look universal fit
- Large lip area conforms to fender flares and body panels
- Soft radii to follow body curves

6416 - 2 pcs. Open Stock



Contour-Fit Splash Guard Truck 7

- Fits most medium-duty trucks
- Custom look universal fit
- Large lip area conforms to fender flares and body panels
- Soft radii to follow body curves

6417 - 2 pcs. Open Stock



Contour-Fit Splash Guard Truck 8

- Fits most heavy-duty trucks
- Custom look universal fit
- Large lip area conforms to fender flares and body panels
- Soft radii to follow body curves

6418 - 2 pcs. Open Stock



Contour-Fit Splash Guard Hardware Kit

- Patented clips create mounting points for splash guards
- Package contains hardware to mount front or rear pair of splash guards
- Corrosion-resistant mounting hardware

6400KT - 6 pcs. Open Stock

Universal-Fit™

Splash Guards are the economical way to add style and protection to your vehicle. Available in a variety of sizes and designs to fit the needs of your car, truck, SUV, RV and trailer



Universal-Fit Splash Guard B - Red Accent

- Universal fit to protect most medium applications
- Molded from heavy-duty material with red reflector
- Mounting hardware included

4766 - 6 pcs. Open Stock



Universal-Fit Splash Guard C - Red Accent

- Universal fit to protect most large applications
- Molded from heavy-duty material with red reflector
- Mounting hardware included

4326 - 6 pcs. Open Stock



Universal-Fit Splash Guard B

- Universal fit to protect most medium applications
- Molded from heavy-duty material
- Mounting hardware included

4754 - 6 pcs. Open Stock



Universal-Fit Splash Guard C

- Universal fit to protect most large applications
- Molded from heavy-duty material
- Mounting hardware included

4322 - 6 pcs. Open Stock



Universal-Fit Splash Guard C - 4X4

- Universal fit to protect most large applications
- Molded from heavy-duty material with silver 4X4 insignia
- Mounting hardware included

4320 - 6 pcs. Open Stock



Universal-Fit Splash Guard

- Universal fit for pick-up trucks, vans and RVs
- Textured black rubber for a long lasting fit
- Easy installation with pre-marked mounting location

5526 - 4 pcs. Open Stock

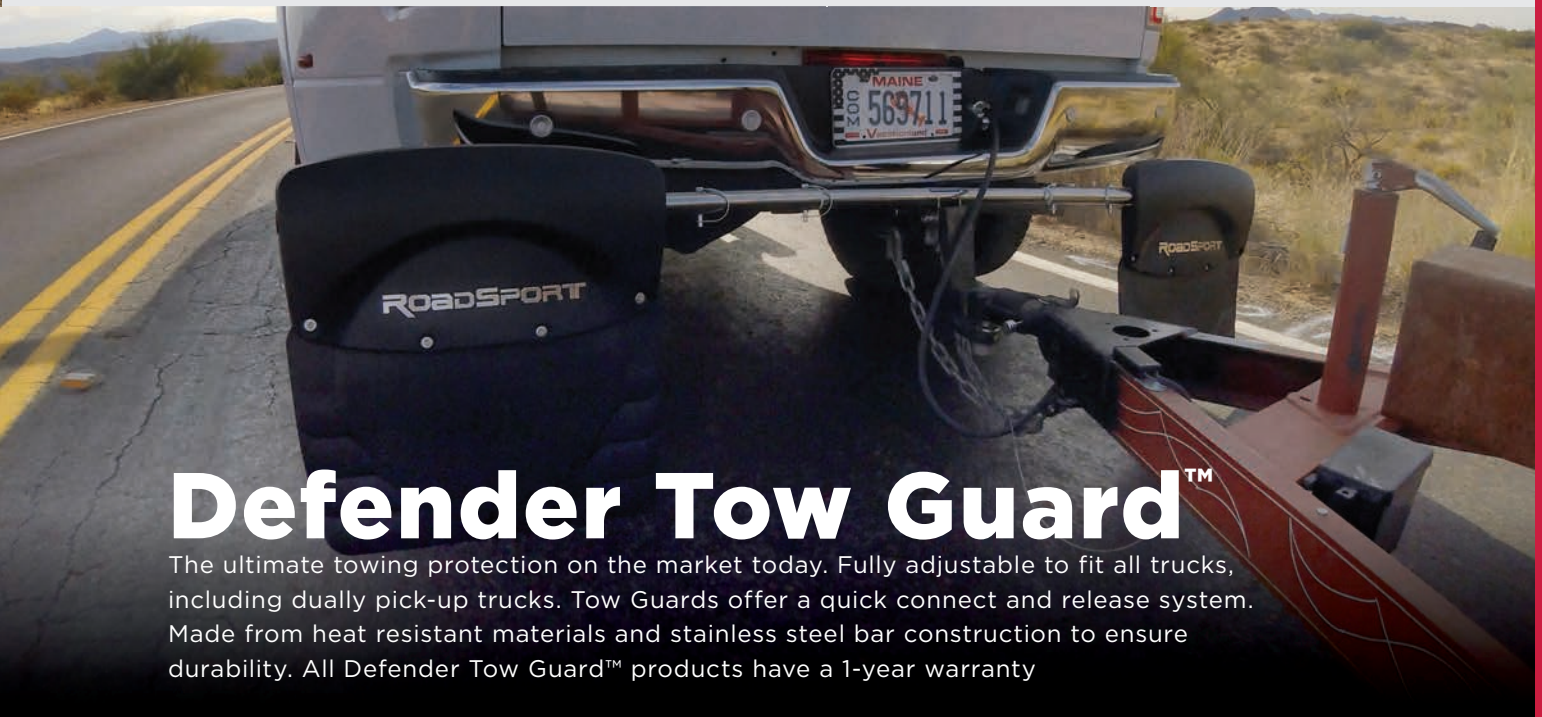

Defender Tow Guard™

The ultimate towing protection on the market today. Fully adjustable to fit all trucks, including dually pick-up trucks. Tow Guards offer a quick connect and release system. Made from heat resistant materials and stainless steel bar construction to ensure durability. All Defender Tow Guard™ products have a 1-year warranty



Defender Tow Guard™

- Fits all pick-up trucks, duallys and RVs
- Easily installed and removed when not towing
- Quick release pins for easy on & off
- Fits most 2" draw bars

3304 - 1 pc. Open Stock



Roadguard Tow Guard™

- Fits all light-duty pick-up trucks and SUVs
- Easily installed and removed when not towing
- Fully adjustable from RV to SUV
- Fits most 1-1/4" or 2" draw bars

3305 - 2 pcs. Open Stock

LIGHTS THE WAY™



50+
YEARS

**RECOGNIZED
AND TRUSTED
BRAND FOR
OVER 50 YEARS**

For five decades, Blazer® has delivered vehicle lighting solutions to heavy-duty trucks, farm/ag, performance, commercial and off-road enthusiasts. Focused on high performance and overall visibility, Blazer® lights the way!

INSIGHTFUL INNOVATION

We follow a consistent philosophy, leveraging consumer insights to drive product innovation

EXCEPTIONAL VALUE

By delivering patented products at competitive prices, we provide the right balance between quality, cost and performance



AUXILIARY & OFF-ROAD LIGHTING



OFF-ROAD LIGHTING

Quality, Performance, and Durability

We are obsessed with every little detail to make sure that our customers have a 5 star experience



Radio Frequency Interference Shielding



IP67 Dust and Water Protection



Compact Housing Design Reduces Wind Noise at All Speeds



Fast and Easy Installation



Adjustable Mounting Brackets and Hardware Included



Off-Road Tough With High Output LEDs, Aluminum Housings, and High Impact Lenses



Award-Winning Innovation

LED Technology

- ABLE TO WITHSTAND SHOCK, VIBRATION, AND EXTREME TEMPERATURES •
- SUPERIOR OPERATIONAL LIFESPAN... UP TO 30,000 HOURS •
- NO WARM UP PERIOD - LIGHTS UP INSTANTLY •



OPTIMIZING CONSUMER SHOPABILITY AND USER SATISFACTION

Blazer® makes it easier for you and your customer with a simplified retail communication strategy. The introduction of color-coded category segmentation quickly orients your shopper to the proper type of product, and a clear communication system helps drive step-up sales for a more rewarding shopping and user experience



OFF-ROAD



ACCESSORY



WORK



WARNING



DRIVING/AXXENT®



INTRODUCING THE HI-DEF SERIES™ Engineered To Deliver Better Visibility



True
“Ditch-to-Ditch”
Visibility



More Visibility
Directly Ahead
on the Trail



HIDEF SERIES™

**WIDE VIEW™
ADVANTAGE**

Enhanced light reflecting technology provides 170 degree visibility from ditch-to-ditch and delivers a 44% wider field of view compared to our standard beam patterns

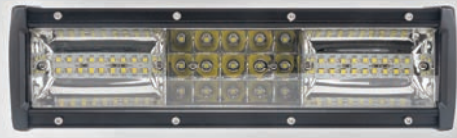

CWL52210 - 11.5" **Class 1** Two patterns for warning use: Amber-only Flash and White-only Flash

Two patterns for light bar use: White-only and Amber-only



CWL5212K - 23"



CWL521 - 11.5"

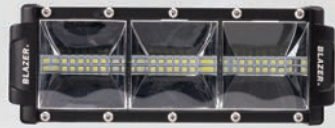

CWL526 - 7.5"



CWL528 - 6.5"



CWL529 - 3.5"

LUMENS

Part Number	Beam Pattern	Length (IN)	Amp Draw	Raw	Effective
CWL52210	SPOT/FLOOD/WARNING	11.5"	2.8	4,000	2,780
CWL5212K	SPOT/FLOOD	23"	4.0	3,000	2,000
CWL521	SPOT/FLOOD	11.5"	1.6	2,600	1,600
CWL526	FLOOD	7.5"	0.9	1,800	1,200
CWL528	SPOT/FLOOD	6.5"	1.43	2,900	1,700
CWL529	SPOT/FLOOD	3.5"	1.0	2,500	1,500

Raw lumen - theoretical output from LEDs / Effective lumen - maximum output from LEDs in housing. Please check local and state laws before installing this product onto your vehicle.





CWL522 - 22" Class 1 Two patterns for warning use:
Amber-only Flash and White-only Flash

Two patterns for light bar use:
White-only and Amber-only



CWL522C - 22"



CWL527 - 20"

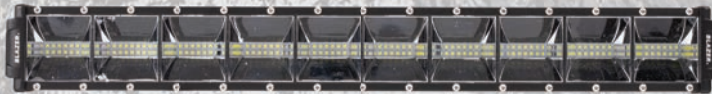

CWL525 - 17.5"

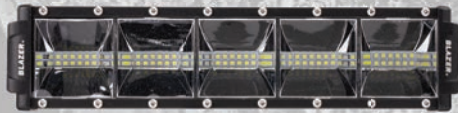

CWL523 - 11.5"

LUMENS

Part Number	Beam Pattern	Length (IN)	Amp Draw	Raw	Effective
CWL522	SPOT/FLOOD/WARNING	22"	6.0	7,920	6,011
CWL522C	SPOT/FLOOD	22"	6.0	7,920	6,011
CWL527	FLOOD	20"	4.0	6,000	4,800
CWL525	FLOOD	17.5"	2.8	4,800	3,600
CWL523	FLOOD	11.5"	1.9	3,000	2,400

Raw lumen - theoretical output from LEDs / Effective lumen - maximum output from LEDs in housing.
Please check local and state laws before installing this product onto your vehicle.



HIDEF SERIES™

CLEAR VIEW™ ADVANTAGE

SEE MORE CLEARLY—WITH
IMPROVED OPTICS

Exclusive light reflecting technology engineered with a unique combination of optimized reflector cups and lenses to provide 25% more focused light straight ahead



C3022K - 22"



CWL520 - 22"

Three lights in one - use entire light bar, or fog only or spot only by turning unit off and on to advance to next pattern



CWL113 - 14"



CWL118 - 8"



CWL514 - 4"

LUMENS

Part Number	Beam Pattern	Length (IN)	Amp Draw	Raw	Effective
C3022K	SPOT/FOG	22"	8.4	9,200	5,700
CWL520	COMBO/SPOT/FOG	22"	6.0	7,920	4,190
CWL113	SPOT/FOG	14"	1.8	2,400	1,500
CWL118	SPOT/FOG	8"	0.9	1,500	830
CWL514	FLOOD	4"	1.2	1,600	850

*Raw lumen - theoretical output from LEDs / Effective lumen - maximum output from LEDs in housing.
Please check local and state laws before installing this product onto your vehicle.*



CWL552D - 52"



CWL552S - 52"



CWL536D - 38"



CWL536S - 38"



CWL524D - 24"



CWL524S - 24"

LUMENS

Part Number	Beam Pattern	Length (IN)	Amp Draw	Raw	Effective
CWL552D	SPOT/FOG	52"	17.6	20,000	13,500
CWL552S	SPOT/FOG	52"	8.4	10,000	6,800
CWL536D	SPOT/FOG	38"	12.7	14,400	11,100
CWL536S	SPOT/FOG	38"	6.0	7,200	6,000
CWL524D	SPOT/FOG	24"	7.5	9,600	5,800
CWL524S	SPOT/FOG	24"	3.8	4,800	3,800

Raw lumen - theoretical output from LEDs / Effective lumen - maximum output from LEDs in housing.
Please check local and state laws before installing this product onto your vehicle.

AUXILIARY LIGHTING

Blaze your own trail with Blazer® lighting solutions. Blazer® lighting products are engineered with high performance components that maximize durability, provide for ease of installation and optimize light visibility where and when you need it most. **BLAZER® LIGHTS THE WAY™**





Halogen 6.5" Spot Light

C52CW

- Heavy-duty steel housing with stainless steel rims and double insulated glass lens
- Lumens: 1,400 Raw, 1,000 Effective - Replaceable 100 Watt quartz halogen bulb
- Current Draw: 6.0 Amps
- Includes mounting bracket and hardware



4 Pk LED White Rock Light Kit

CWL515

- Compact design - can be mounted anywhere with the included flat or curved mounting grommets
- High-impact polycarbonate lens and reinforced resin housing
- Current draw: 0.14 Amps per light
- Includes 4 lights, quick-connecting wiring harness, 4x flat mounting grommets, 4x curved mounting grommets and mounting hardware



LED 6" Spot Light Bar

CWL1116

- Compact size and shape
- Single stud mount
- Lumens: 900 Raw, 630 Effective
- Current draw: 0.5 Amps
- Includes light, mounting bracket and hardware



LED 7.5" Spot/Flood Light Bar

CWL518

- Dual-chip design produces more lumens due to improved technology and a larger surface area
- Lumens: 3,200 Raw, 1,600 Effective
- Current draw: 2.0 Amps
- Includes light, mounting brackets and hardware



LED 7.5" Spot Light Bar

CWL0006

- Compact, slim line design
- Lumens: 1,260 Raw, 850 Effective
- Current draw: 0.9 Amps
- Includes light, mounting brackets and hardware



LED 14" Spot/Flood Light Bar

CWL513

- Dual-chip design produces more lumens due to improved technology and a larger surface area
- Lumens: 6,700 Raw, 3,000 Effective
- Current draw: 4.0 Amps
- Includes light, mounting brackets and hardware



LED 20" Spot/Flood Light Bar

CWL0020

- Compact, slim line design
- Lumens: 3,780 Raw, 2,300 Effective
- Current draw: 2.7 Amps
- Includes light, mounting brackets and hardware

LED CUBES

COMPACT AND VERSATILE... MOUNT ANYWHERE ADDITIONAL LIGHT IS NEEDED



FLOOD LIGHT

Diffuses light to illuminate a wide area



C3072K - 3"



C3073KFM - 3"
Flush Mount

LUMENS

Part Number	Beam Pattern	Length (IN)	Amp Draw	Raw	Effective
C3072K	FLOOD	3"	1.2	1,720	1,200
C3073KFM	FLOOD	3"	0.75	1,720	1,200

Raw lumen - theoretical output from LEDs / Effective lumen - maximum output from LEDs in housing.
Please check local and state laws before installing this product onto your vehicle.



C3073K - 3"



CWL0022 - 2" - 2 PACK



* C3075K - 4" x 3" - 2 Pk

Amber Only Or White Only

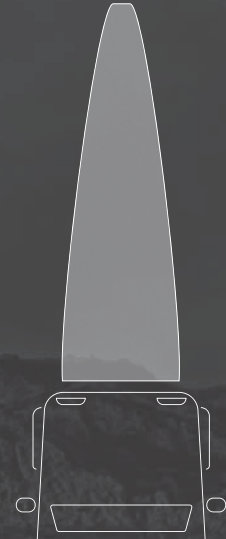

SPOT LIGHT

Projects a narrow, intense beam of light to illuminate directly ahead of you

LUMENS

Part Number	Beam Pattern	Length (IN)	Amp Draw	Raw	Effective
C3073K	SPOT	3"	1.2	1,320	1,100
CWL0022	SPOT	2"	0.71	1,230	846
C3075K	SPOT*	4" x 3"	0.80	900	575

Raw lumen - theoretical output from LEDs / Effective lumen - maximum output from LEDs in housing. Please check local and state laws before installing this product onto your vehicle.

WIRELESS MANAGEMENT SYSTEM

Reduces light system installation by hours. No need to drill through the firewall, install switches, relays or fuses

- ✓ CWL623 controls 5 channels, allowing operation of 4+ lights and accessories
- ✓ Energy/battery saving: Entire unit turns off after 48 hours of non-use if a light or switch is left on accidentally
- ✓ CWL622 has up to 100 feet of wireless range



Award-Winning
Innovation

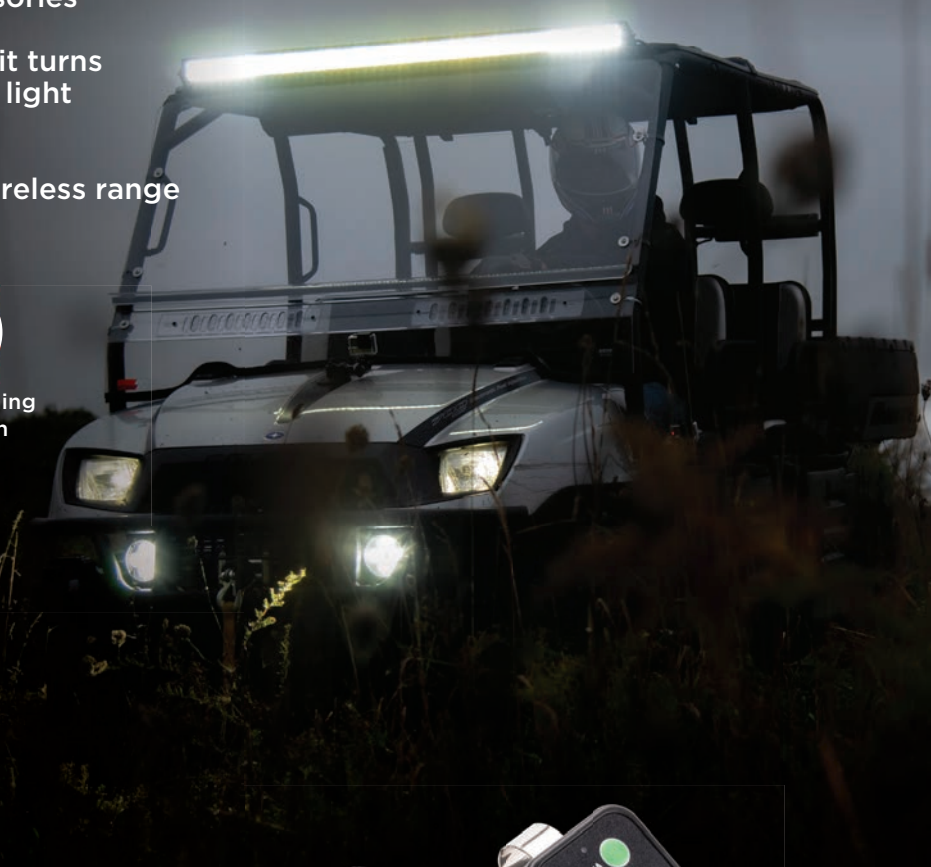

Quick Install Light Kit With Phone App

CWL623

- Includes module and app (phone not included)
- Phone app operates 4 lights (2 each at 18 and 5 amps)
- Extra terminal for warning light pattern changes
- Easy installation - no drilling through firewall or adding switches to dash
- Sleep mode automatically turns off after 48 hrs. preventing damage to the lights and battery

Quick Install Light Kit With Remote

CWL622

- Includes module and remote
- Remote control operates 4 lights (2 each at 18 and 5 amps)
- Easy installation - no drilling through firewall or adding switches to dash
- Sleep mode automatically turns off after 48 hrs. preventing damage to the lights and battery

LED LIGHT KITS WITH REMOTES

Fast and easy installation - no drilling into dash, no wiring, switch, relay, or fuse needed. It's all included in the remote system

Each Kit Includes:

- 26" double-row light bar or 3" cube set
- 9' lead wires from the light(s)
 - eliminates need to add/solder more wiring
- Mounting brackets and hardware
- Module & remote



2 Pk LED 3" x 3" Cubes With Remote

CWL51222

- Includes mounting brackets, hardware, engine compartment module, remote
- Each light built with 9 ft lead wire
- Ability to run 4+ lights (2 each at 18 amps and 5 amps) with included remote control (CWL51222 5amp terminal will power both cubes in terminal - add other lights to remaining terminals)
- Fast & easy installation - no drilling into dash, no wiring, no switch, no relay, no fuse - it's all included in the remote system



LED 26" Double Row Light Bar Kit With Remote

CWL52450

- Includes mounting brackets, hardware, engine compartment module, remote
- Light bar built with 9 ft lead wire
- Ability to run 4+ lights (2 each at 18 amps and 5 amps) with included remote control
- Fast & easy installation - no drilling into dash, no wiring, no switch, no relay, no fuse - it's all included in the remote system

Both units will power lights, horns, coolers, power to a winch, etc. for versatility of function

LUMENS

Part Number	Beam Pattern	Length (IN)	Amp Draw	Raw	Effective
CWL51222	FLOOD	3"	1.1	1,600	1,000
CWL52450	SPOT/FLOOD	26"	4.8	7,200	6,090

Raw lumen - theoretical output from LEDs / Effective lumen - maximum output from LEDs in housing. Please check local and state laws before installing this product onto your vehicle.

AUXILIARY LIGHTING ACCESSORIES



CWL610

Quick-Connect Wiring Harness

CWL610 - 1 Light

CWL615 - 2 Lights

- Harness includes quick connecting plug, 40 amp relay, 30 amp fuse and round toggle switch
- 1 and 2-light wiring harnesses are designed for lighting systems under 200 watts
- 9', 16 gauge wire
- Quick-connecting plugs are water resistant and easy to install



Quick-Connect Wiring Harness (Heavy-Duty)

CWL620 - 1 Light

- Harness includes quick connecting plug, 40 amp relay, 30 amp fuse and round toggle switch
- Heavy-duty wiring harness is designed for systems 300 W and over (ie: CWL552D)
- 9', 16 gauge wire
- Quick-connecting plugs are water resistant and easy to install



Quick-Connect Plug Set

CWL625

- Includes male and female plugs with 6" leads
- Water resistant and easy to install
- Connect to light, wiring and/or harness



Round On-Off Switch

CWL624

- Fits in 0.75" diameter hole
- Illuminated switch lights red when on

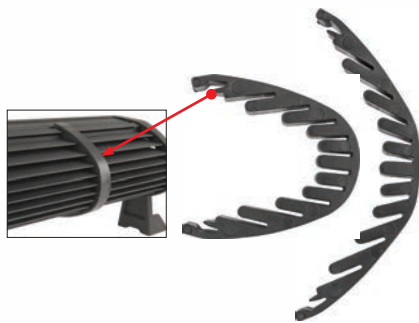

10 Pack Noise Reducing Inserts

CWL627

- PVC inserts reduce vibration noise caused by wind, road and terrain
- For Blazer® double row LED light bars 22" and longer



24 Piece Theft Prevention Hardware

CWL626

- Includes 2 allen wrenches, 5 lock nuts and 17 screws
- Unique bolt head deters theft - standard wrenches or screwdrivers will not remove light



Round Mounting Brackets

CWL636 - 2" Diameter

CWL637 - 1.75" Diameter

CWL638 - 1.5" Diameter

- Designed for mounting a single light or light bar on round or angled bars or frames
- Powder coated, durable steel frame for long lasting use
- Includes bracket, mounting hardware and padding to protect the mounting surface
- Mount can be adjusted and rotated 360° to fit height or width requirements



Universal Mounting Bracket

CWL639

- Designed for mounting a single light or light bar on round or angled bars or frames
- Adjustable from 1.5" to 2.25"
- Adjustable 360° mounting
- Adhesive padding to protect painted surfaces

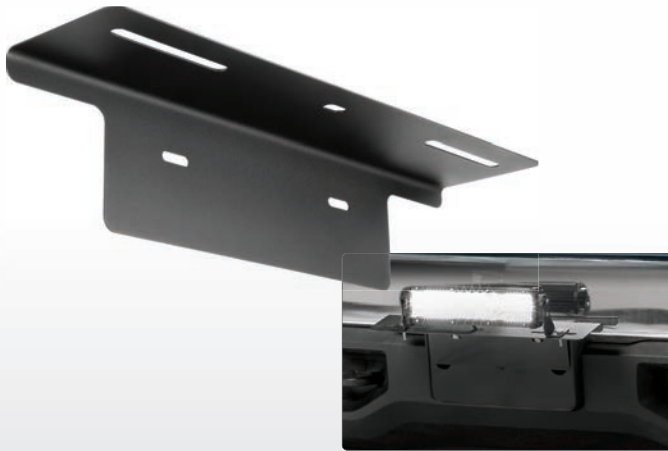

Universal License Plate Bracket

CWL692

- Designed to use the holes that USA and Canadian license plates fit into (license plate will attach to the bracket, as well)
- Powder coated, durable steel frame for long lasting use
- Fits stud, post and side mounting brackets - fits all Blazer® lights 14" and under
- Bracket can be used on bumper, racks and other locations. Great for cameras, too
- No drilling required



6" CWL630 on 7" Double Row Light Bar

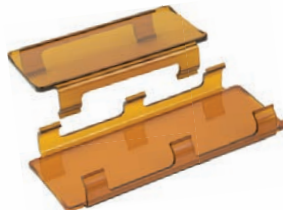

2 Pk Light Covers

CWL630 - Amber

CWL631 - Black

- Easy to snap on and off 6" and 8" segments
- Fits most double row light bars
- Polycarbonate lens - durable and shatter proof (protects lens when not in use)
- CWL630 amber lens improves visibility in fog or snow
- CWL631 black lens covers satisfy regulations in most states/provinces (check local laws)

WARNING / EMERGENCY

LED and Halogen

Convenient 12 V plug or battery powered options make installation easy with non-scratch heavy-duty magnetic base for secure mount. Most units come with a permanent mounting option

The three SAE classifications for warning lights:

- Class 1: Emergency
- Class 2: On-road/Off-Road/Indoor
- Class 3: Off-Road/Indoor



Some units now come with a "HEATED LENS" option that is designed to automatically de-ice the surface of the lens. Look for the "HEATED LENS" icon to find this advanced feature



LED 11.5" Spot/Flood/Warning Combination Light

CWL52210 **Class 1**

- Multicolor beam patterns - switch between white and amber constant on or flashing
- Ditch-to-ditch visibility - 170 degree light beam pattern perfect for illuminating uneven terrain, dark roads or low visibility conditions
- Lumens: 5,000 Raw, 3,500 Effective
- Current draw: 2.8 Amps
- Includes light, mounting brackets and hardware

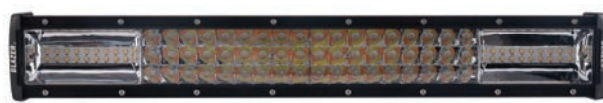

LED 22" Spot/Flood/Warning Combination Light

CWL522 **Class 1**

- Multicolor beam patterns - switch between white and amber constant on or flashing
- Ditch-to-ditch visibility - 170 degree light beam pattern perfect for illuminating uneven terrain, dark roads or low visibility conditions
- Lumens: 7,920 Raw, 6,011 Effective
- Current draw: 6.0 Amps
- Includes light, mounting brackets and hardware



LED Magnetic Light Bar, Amber/White LEDs

C4850CAC **Class 2**

- Low-profile, aerodynamic design stands 3.2" from the surface
- Flash pattern(s): 9 - 3 amber, 3 white, 3 combination
- 12 V power cord includes plug with on/off and pattern selection switch
- Optional permanent mount (hardware not included)



LED Magnetic Light Bar, Amber/White LEDs

C4850CACH **Class 2**

- Automatic heated lens melts away snow and ice for continued visibility in winter-like conditions
- Low-profile, aerodynamic design stands 3.2" from the surface
- Flash pattern(s): 9 - 3 amber, 3 white, 3 combination
- 12 V power cord includes plug with on/off and pattern selection switch
- Optional permanent mount (hardware not included)



LED Micro Magnetic Light Bar, Amber/White LEDs

C4856CAC **Class 2**

- Low-profile, aerodynamic design stands 2" from the surface
- Flash pattern(s): 9 - 3 amber, 3 white, 3 combination
- 12 V power cord includes plug with on/off and pattern selection switch
- Optional permanent mount (hardware not included)



LED Stealth-Black Magnetic Light Bar, Amber LEDs

C4857CAC **Class 2**

- Low-profile, aerodynamic design stands 3" from the surface
- Flash pattern(s): 11
- 12 V power cord includes plug with on/off and pattern selection switch
- Optional permanent mount (hardware not included)



LED Mini Magnetic Light Bar

C4855AW **Class 1**

- Low-profile, aerodynamic design stands 2.25" from the surface
- Flash pattern(s): 8
- 12 V power cord includes plug with on/off and pattern selection switch
- Optional permanent mount (hardware not included)



LED Mini Magnetic Light Bar, Amber LEDs

C4855CAW **Class 2**

- Low-profile, aerodynamic design stands 2.25" from the surface
- Flash pattern(s): 8 amber
- 12 V power cord includes plug with on/off and pattern selection switch
- Optional permanent mount (hardware not included)



LED Mini Magnetic Light Bar, Amber/White LEDs

C4855CAC **Class 2**

- Low-profile, aerodynamic design stands 2.25" from the surface
- Flash pattern(s): 9 - 3 amber, 3 white, 3 combination
- 12 V power cord includes plug with on/off and pattern selection switch
- Optional permanent mount (hardware not included)



Halogen Magnetic Revolving Light Bar

C4500AW **Class 1**

- Features 2 revolving chrome reflectors with 2 replaceable H1 55W bulbs
- Flash pattern(s): 1
- 12' power cord includes plug with on/off switch
- Optional permanent mounting (hardware not included)



LED Magnetic Light Bar

C4850AW **Class 1**

- Low-profile, aerodynamic design stands 3.2" from the surface
- Flash pattern(s): 21
- 12 V power cord includes plug with on/off and pattern selection switch
- Optional permanent mount (hardware not included)



LED Low-Profile Magnetic Strobe Beacon, Amber LEDs

C38CAW **Class 1**

- Low-profile aerodynamic design stands 3" from the surface
- Flash pattern(s): 8
- 12 V power cord includes plug with on/off and pattern selection switch
- Optional permanent mount (hardware not included)



LED Short Profile Magnetic Alert Beacon, Amber/White LEDs

C36CAC **Class 2**

- Low-profile aerodynamic design stands 2" from the surface
- Flash pattern(s): 9 - 3 amber, 3 white, 3 combination
- 12 V power cord includes plug with on/off and pattern selection switch
- Optional permanent mount (hardware not included)



LED Standard Profile Magnetic Alert Beacon, Amber/White LEDs

C37CAC **Class 2**

- Low-profile aerodynamic design stands 3.4" from the surface
- Flash pattern(s): 9 - 3 amber, 3 white, 3 combination
- 12 V power cord includes plug with on/off and pattern selection switch
- Optional permanent mount (hardware not included)



LED Tall Profile Magnetic Alert Beacon, Amber/White LEDs

C41CAC **Class 2**

- Low-profile aerodynamic design stands 5" from the surface
- Flash pattern(s): 9 - 3 amber, 3 white, 3 combination
- 12 V power cord includes plug with on/off and pattern selection switch
- Optional permanent mount (hardware not included)



LED Tall Profile Magnetic Alert Beacon, Amber/White LEDs

C41CACH **Class 2**

- Automatic heated lens melts away snow and ice for continued visibility in winter-like conditions
- Low-profile aerodynamic design stands 5" from the surface
- Flash pattern(s): 9 - 3 amber, 3 white, 3 combination
- 12 V power cord includes plug with on/off and pattern selection switch
- Optional permanent mount (hardware not included)



LED Magnetic Strobe Beacon

C48AW **Class 3**

- Single flash feature - 100 flashes per minute
- 12 V power cord
- Optional permanent mount (hardware not included)



LED Magnetic Strobe Beacon

C48AWH **Class 3**

- Automatic heated lens melts away snow and ice for continued visibility in winter-like conditions
- Single flash feature - 100 flashes per minute
- 12 V power cord
- Optional permanent mount (hardware not included)



LED Magnetic Strobe Beacon

C43A **Class 3**

- Smart on/off sensor automatically turns the light on in darkness and off in daylight
- Flash pattern(s): 4
- No wiring necessary - operated on 2 x D batteries (not included)



LED Round Strobes, Amber/White LEDs

C4842 **Class 3**

- 1.5" diameter
- Low-profile design stands 0.7" from the surface
- Flash pattern(s): 9 - 3 amber, 3 white, 3 combination
- Each light includes a 3-wire pigtail and mounting hardware to mount to the grille of the vehicle



LED Rectangular Strobes, Amber/White LEDs

C4843 **Class 2**

- Low-profile design stands 0.5" from the surface
- Flash pattern(s): 9 - 3 amber, 3 white, 3 combination
- Each light includes a 3-wire pigtail and mounting hardware to mount to the grille of the vehicle



LED 4" Round Strobe Light

5441B - Light Only Wig Pattern - Bulk

5442B - Light Only Wag Pattern - Bulk

- Grommet mount installation
- Alternating (wig-wag) or synchronous strobe pattern
- Ideal for emergency vehicles, construction equipment, work trucks and any vehicle needing greater visibility
- Current draw: 0.45 Amps



LED 6" Oval Strobe Light

5641B - Light Only Wig Pattern - Bulk

5642B - Light Only Wag Pattern - Bulk

- Grommet mount installation
- Alternating (wig-wag) or synchronous strobe pattern
- Ideal for emergency vehicles, construction equipment, work trucks and any vehicle needing greater visibility
- Current draw: 0.45 Amps



LED Magnetic Hazard Light

C42A **Class 2**

- Ideal for use on barricades or traffic drums in work zones or parking lots, warehouses and stock rooms
- Flash pattern(s): 1
- Solar charging or micro B USB charging possible (charger not included) Solar charging works while light is on (best if light is turned off) Light has three switch positions: always on, off, or turns on at dusk and off at dawn
- Lithium-ion battery, included



C6350

Class 2

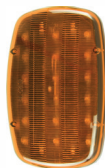

C6350A

Class 3

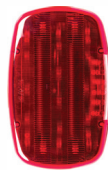

C6355

Class 3

LED Magnetic Emergency Light

C6350 - Red

C6350A - Amber

C6355 - Red with White Work Light

- C6355 has an additional work light on the side of the unit
- Flash pattern(s): 2
- No wiring necessary - operated on 4 x AA batteries (not included)
- Optional freestanding setup

VISIBILITY AND SAFETY...

Two benefits **BLAZER® WARNING LIGHTS** help to provide whether working during the day, or at night. 360 degrees of high-performance lighting will survive in the harshest of conditions



Auxiliary Lighting For Enhanced Visibility

Blazer® auxiliary lighting will enhance any vehicle's factory head lamps while providing further visibility. Fog and driving lights feature corrosion resistant housing and durable lenses to provide protection against the elements. AXXENT® lights add lighting to the vehicle to help the vehicle be seen - similar to daytime running lights



Halogen 4" AXXENT® Light Kit

C3062K - Clear Lens

- Kit includes 2 lights, wiring kit, illuminated on/off switch, mounting brackets, hardware and installation instructions
- Heavy-duty steel housing and durable polycarbonate lens provide protection against the elements
- Replacement 12V/55W/H3 bulb
- Current draw: 3.2 Amps



LED 3.5" Driving Light Kit

C3067K

- Kit includes 2 lights, wiring kit, illuminated on/off switch, mounting brackets, hardware and installation instructions
- Die cast aluminum housing and durable polycarbonate lens provide protection against the elements
- 283 effective lumens
- Off-road use only
- Current draw: 0.6 Amps



LED 2.5" AXXENT® Light Kit

AX4020K

- Kit includes 2 lights, wiring kit, illuminated on/off switch, mounting brackets, hardware and installation instructions
- ABS plastic housing and durable PMMA lens provide protection against the elements
- Current draw: 0.12 Amps



LED 4" AXXENT® Light Kit

AX4050K

- Kit includes 2 lights, wiring kit, illuminated on/off switch, mounting brackets, hardware and installation instructions
- ABS plastic housing and durable PMMA lens provide protection against the elements
- Current draw: 0.04 Amps



Halogen 3" x 5.5" Driving Light Kit

DF1073KB

- Kit includes 2 lights, wiring kit, illuminated on/off switch, mounting brackets, hardware and installation instructions
- ABS plastic housing and glass lens provide protection against the elements
- Bottom vented to burn off internal condensation
- Replaceable 12V/55W/H3 bulbs
- Current draw: 5.0 Amps



Halogen 4" x 7" Driving Light Kit

CW8002K

- Kit includes 2 lights, wiring kit, illuminated on/off switch, mounting brackets, hardware and installation instructions
- Molded resin housing and glass lens provide protection against the elements
- Lamps feature a rock guard to protect lens from flying debris
- For on or off road use - Designed to meet SAE requirements for driving lights
- Current draw: 5.0 Amps



Halogen 3" x 5.5" Fog Light Kit

DF1075KB

- Kit includes 2 lights, wiring kit, illuminated on/off switch, mounting brackets, hardware and installation instructions
- ABS plastic housing and amber coated glass lens provide protection against the elements
- Replacement 12V/55W/H3 bulbs
- Current draw: 5.0 Amps



30 AMP Relay

N005W

- Allows switching and adding of multiple electronic devices within vehicle's power generating system
- 12 V
- Current draw: 30 Amps



Auxiliary Wiring Kit for 12V Accessories

MM510

- Kit includes 40 amp relay, illuminated on/off switch and all connectors and fuses
- Switch is rated at 15 amps and 15 VDC
- Current and power circuits have in-line fuses

Flood, Spot, and Trapezoid Beam Patterns

Heavy-duty and high output lights engineered with high performance components for agricultural and industrial use

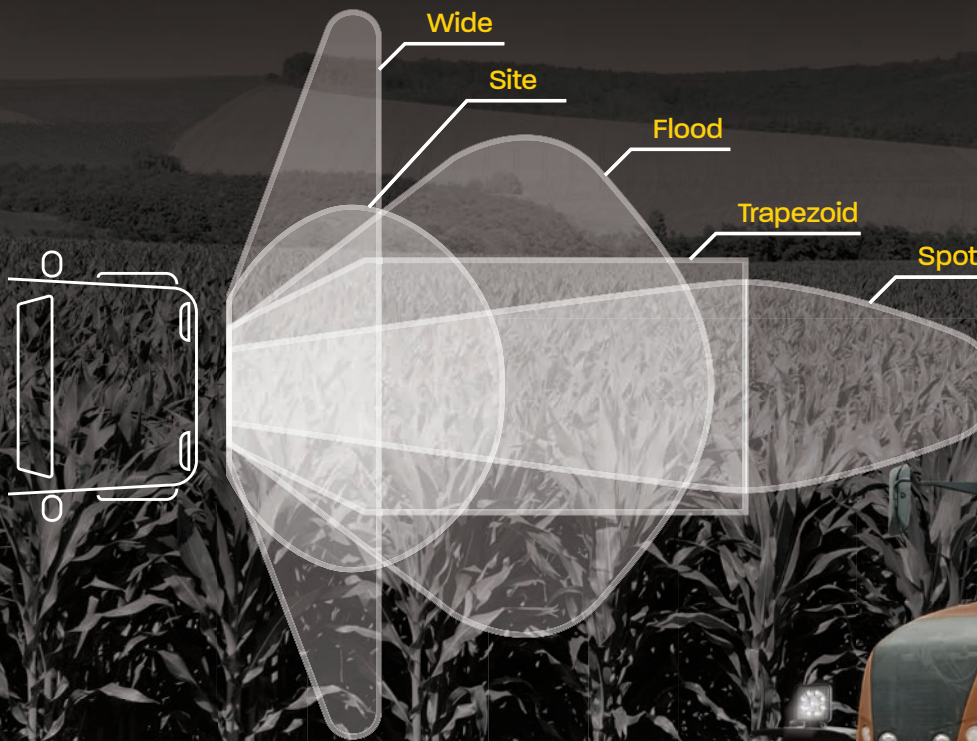

LED 4" Work Light

CWL5042 - Flood Beam, 2K Lumens

- Die cast aluminum housing and high-impact polycarbonate lens
- Lumens: 3,600 Raw, 2,000 Effective
- Current draw: 2.0 Amps
- Includes light, mounting bracket and hardware



LED 4" Work Light

CWL5043 - Flood Beam, 3K Lumens

- Die cast aluminum housing and high-impact polycarbonate lens
- Lumens: 4,600 Raw, 3,000 Effective
- Current draw: 3.0 Amps
- Includes light, mounting bracket and hardware

Raw lumen - theoretical output from LEDs / Effective lumen - maximum output from LEDs in housing.
Please check local and state laws before installing this product onto your vehicle.



2.5" Work Lights

CWL0003 - Flood Beam

- Die cast aluminum housing and high-impact polycarbonate lens
- Lumens: 2,000 Raw, 1,200 Effective
- Current draw: 1.5 Amps



9" Work Lights

CWL0004 - Site Beam

- Die cast aluminum housing and high-impact polycarbonate lens
- Lumens: 1,600 Raw, 1,200 Effective
- Current draw: 2 Amps



15.5" Work Lights

CWL0005 - Site Beam

- Die cast aluminum housing and high-impact polycarbonate lens
- Lumens: 3,600 Raw, 2,400 Effective
- Current draw: 3.5 Amps



2 Pk LED 4" Work Lights

CWL503TWP - Flood Beam

- Die cast aluminum housing and high-impact polycarbonate lens
- Lumens: 900 Raw, 625 Effective
- Current draw: 1.1 Amps
- Includes 2 lights, mounting brackets and hardware



2 Pk LED 4.5" Work Lights

CWL504TW - Flood Beam

- Die cast aluminum housing and high-impact polycarbonate lens
- Lumens: 1,450 Raw, 1,200 Effective
- Current draw: 1.15 Amps
- Includes 2 lights, mounting brackets and hardware



LED 4.5" Work Light

CWL504 - Flood Beam

- Die cast aluminum housing and high-impact polycarbonate lens
- Lumens: 1,560 Raw, 1,200 Effective
- Current draw: 1.3 Amps
- Includes light, mounting bracket and hardware



2 Pk LED 2" Work Lights

CWL507TW - Flood Beam

- Die cast aluminum housing and high-impact polycarbonate lens
- Lumens: 1,200 Raw, 840 Effective
- Current draw: 0.7 Amps
- Includes 2 lights, mounting brackets and hardware



LED 5" Work Light

CWL510 - Spot Beam

- Die cast aluminum housing and high-impact polycarbonate lens
- Lumens: 3,500 Raw, 2,600 Effective
- Current draw: 2.5 Amps
- Includes light, mounting bracket and hardware



LED 5" x 2" Flood Light

CWL509 - Flood Beam

- Die cast aluminum housing and high-impact polycarbonate lens
- Lumens: 2,000 Raw, 950 Effective
- Current draw: 1.65 Amps
- Includes light, mounting bracket and hardware

Raw lumen - theoretical output from LEDs / Effective lumen - maximum output from LEDs in housing.
Please check local and state laws before installing this product onto your vehicle.



Halogen 5" Work Light

C123 - 12V - Trapezoid Beam

C125 - 6V - Trapezoid Beam

- Stud mount installation
- Shock proof rubber housing and glass lens
- Replaceable #4411-1 halogen bulb
- Current draw: 3.5 Amps
- Includes light, mounting bracket and hardware



Halogen 7" x 4" Work Light

C8005W - Trapezoid Beam

C8006W - Spot Beam

C8007W - Flood Beam

- Stud mount installation
- Corrosion resistant molded housing and grill
- Replaceable H3-55W halogen bulb
- Current draw: 3.5 Amps
- Includes light, mounting bracket and hardware



Halogen 6" x 3" Rear Mount Tractor Light

C8011 - Trapezoid Beam

C8010 - Flood Beam

- Surface mount installation
- Corrosion resistant molded housing and glass lens
- Replaceable 55W halogen bulb
- Current draw: 5.0 Amps
- Includes light, mounting bracket and hardware



LED 4" Work Light

CWL506 - Flood Beam

- Die cast aluminum housing and high-impact polycarbonate lens
- Lumens: 1,560 Raw, 1,200 Effective
- Current draw: 1.3 Amps
- Includes light, mounting bracket and hardware



LED 2" Work Light

CWL507 - Flood Beam

- Die cast aluminum housing and high-impact polycarbonate lens
- Lumens: 1,200 Raw, 600 Effective
- Current draw: 1.2 Amps
- Includes light, mounting bracket and hardware



LED 4" x 3" Work Light

CWL508 - Flood Beam

- Die cast aluminum housing and high-impact polycarbonate lens
- Lumens: 1,200 Raw, 745 Effective
- Current draw: 1.43 Amps
- Includes light, mounting bracket and hardware

*Raw lumen - theoretical output from LEDs / Effective lumen - maximum output from LEDs in housing.
Please check local and state laws before installing this product onto your vehicle.*



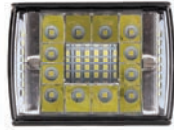

Hi-Def: The Wide View Advantage™
LED 3.5" x 2.5" Work Light

CWL529 - Spot/Flood Beam

- Die cast aluminum housing and high-impact polycarbonate lens
- Lumens: 2,500 Raw, 1,500 Effective
- Current draw: 1.0 Amps
- Includes light, mounting bracket and hardware



Hi-Def: The Wide View Advantage™
LED 6.5" Work Light

CWL528 - Spot/Flood Beam

- Die cast aluminum housing and high-impact polycarbonate lens
- Lumens: 2,900 Raw, 1,700 Effective
- Current draw: 1.43 Amps
- Includes light, mounting bracket and hardware



Hi-Def: The Wide View Advantage™
LED 7.5" Light Bar

CWL526 - Flood Beam

- Aluminum extrusion housing and high-impact polycarbonate lens
- Housing designed to reduce wind noise at highway speeds
- Lumens: 1,800 Raw, 1,200 Effective
- Current draw: 0.9 Amps
- Includes light with lead wire, mounting brackets and hardware



Hi-Def: The Wide View Advantage™
LED 11.5" Light Bar

CWL523 - Flood Beam

- Aluminum extrusion housing and high-impact polycarbonate lens
- Housing designed to reduce wind noise at highway speeds
- Lumens: 3,000 Raw, 2,400 Effective
- Current draw: 1.9 Amps
- Includes light with lead wire, mounting brackets and hardware



Hi-Def: The Wide View Advantage™
LED 17.5" Light Bar

CWL525 - Flood Beam

- Aluminum extrusion housing and high-impact polycarbonate lens
- Housing designed to reduce wind noise at highway speeds
- Lumens: 4,800 Raw, 3,600 Effective
- Current draw: 2.8 Amps
- Includes light with lead wire, mounting brackets and hardware



Hi-Def: The Wide View Advantage™
LED 20" Light Bar

CWL527 - Flood Beam

- Aluminum extrusion housing and high-impact polycarbonate lens
- Housing designed to reduce wind noise at highway speeds
- Lumens: 6,000 Raw, 4,800 Effective
- Current draw: 4.0 Amps
- Includes light with lead wire, mounting brackets and hardware

*Raw lumen - theoretical output from LEDs / Effective lumen - maximum output from LEDs in housing.
Please check local and state laws before installing this product onto your vehicle.*

REFLECTIVE DRIVEWAY MARKERS

Any season! Any Time! Anywhere!

Blazer® Driveway markers are great for marking driveways, parking lots and curbs for snow removal or marking property boundaries

Reflector staffs are made with specialized fiberglass and/or steel that is weather resistant, highly visible and simple to install



2-Sided
Reflector
Markers

Fiberglass
Reflective Tape
Markers

Choose from a
wide variety of
colors, shapes
and sizes!

Multi-Packs
Are Great For
Contractors

Multi-pack options: 4, 8, 24 or 72 pieces





36" Red 2-Sided Driveway Marker

- 376RDM - Red, Single staff with UPC, 8 pcs.**
- 376RDM-8 - Red, 8 pcs.**
- 376RDM-24 - Red, 24 pcs.**

- 2" x 3.25" round reflectors sealed in plastic housing
- 36" galvanized rod is 0.1875" round and corrosion resistant



36" Blue 2-Sided Driveway Marker

- 376BDM - Blue, Single staff with UPC, 8 pcs.**
- 376BDM-8 - Blue, 8 pcs.**
- 376BDM-24 - Blue, 24 pcs.**

- 2" x 3.25" round reflectors sealed in plastic housing
- 36" galvanized rod is 0.1875" round and corrosion resistant

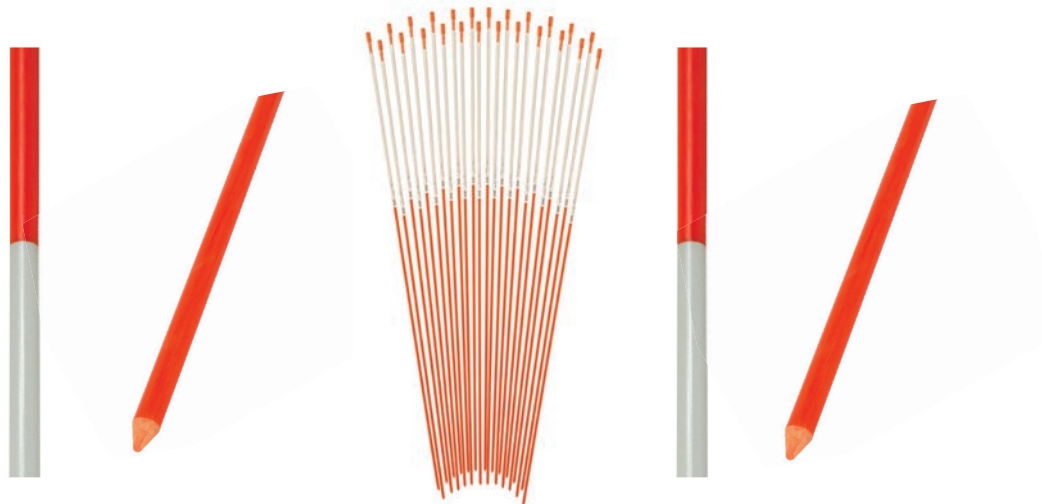

48" Fiberglass Snow Pole Markers

- 3810DM-4 - Orange, 4 pk. Carded, 8 pcs**
- 3810DM-24 - Orange, 24 pcs.**
- 3810DM-72 - Orange, 72 pcs.**

- 48" durable fiberglass pole is 0.25" round and corrosion resistant
- Top 10" is wrapped with high visibility reflective tape and a protective cap on top to prevent splintering when tapping into ground
- Pointed tip for easy installation

72" Orange Fiberglass Snow Pole Marker

- 3720DM - Orange, Single staff with UPC, 12 pcs.**
- 3720DM-24 - Orange, 24 pcs.**

- 72" durable fiberglass pole is 0.25" round and corrosion resistant
- Top 10" is wrapped with high visibility reflective tape and a protective cap on top to prevent splintering when tapping into ground
- Pointed tip for easy installation
- 72" height for areas where snow drifting occurs, or for use in parking lots in order to see the marker above the hood or trunk of most vehicles

UNMATCHED SOLUTIONS TO WEATHER EVERY STORM



MAKING WINTER DRIVING SAFER THROUGH INNOVATION™



WINTER TOOLS

RELENTLESS INNOVATION

We are obsessed with enduring, leading edge, dependable and superior products in every subcategory to enhance the consumer experience

PROVEN EXPERIENCE

Two brands combining for over 100 years of expertise, using and testing the product ourselves, and gaining consumer insights, all to bring our knowledge back to the products we offer

UNRIVALED SELECTION

We are committed to providing the widest and deepest assortment of winter tools to perfectly fit any customer's needs and strategies



MAXX SERIES FORCE™

ICE DOESN'T
STAND A CHANCE!



Offset Chippers Cut
Through Thick Ice

Patented Flex-Blade™
Conforms to Windshield



The Most Powerful Ice Scraper Ever Invented

MAXX-Force™ Series

- 14165 - 65" MAXX-Force Glacier™ Snowbroom - p. 147
- 14161 - 60" MAXX-Force™ Snowbroom - p. 147
- 14185 - 50" MAXX-Force™ Ultimate Crossover Snowbroom - p. 148
- 14151 - 50" MAXX-Force™ Crossover Snowbroom - p. 148
- 14135 - 37" MAXX-Force™ Snowbrush - p. 151
- 14125 - 11" MAXX-Force™ Scraper - p. 154



WINTER TOOLS



800-524-1458



65" MAXX-Force Glacier™ Snowbroom

- MAXX-Force™ offset ice chippers easily cut through thick ice
- XL 13" broom head removes deep snow
- Rubber t-blade squeegee flicks away excess moisture
- Patented 4.5" Flex Blade™ contours to windshield to remove frost

14165 - 12 pcs. Tray Pack



62" POWER-Force Glacier™ Snowbroom

- POWER-Force™ ice chippers easily cut through thick ice
- XL 13" broom head removes deep snow
- Rubber t-blade squeegee flicks away excess moisture
- 4.5" Chisel blade for frost removal

14462 - 12 pcs. Tray Pack



61" BLIZZARD FORCE™ Pivoting Snowbroom

- Large 12.5" broom head with rubber squeegee clears heavy snow quickly
- Strong steel pole easily extends from 39"-61" for super long reach
- Offset chipper design creates maximum leverage points for scoring and removing thick ice on 4.5" Blade

12080 - 12 pcs. Tray Pack



60" MAXX-Force™ Snowbroom

- MAXX-Force™ offset ice chippers easily cut through thick ice
- Non-scratch EVA foam removes deep snow
- Extends up to 60" for maximum reach across windshields
- Patented Flex Blade™ contours to windshield to remove frost

14161 - 12 pcs. Tray Pack

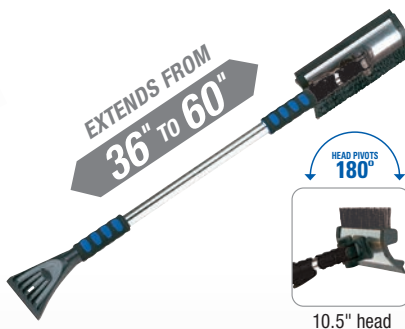

60" Quick-Lock™ Pivoting Snowbroom

- Quick-Lock™ extension pole reaches 60"
- Extra wide scraper blade
- Pivoting soft bristle snowbroom and squeegee
- Great for trucks, SUVs and RVs

80037 - 6 pcs. Open Stock
80038 - 6 pcs. Tray Pack

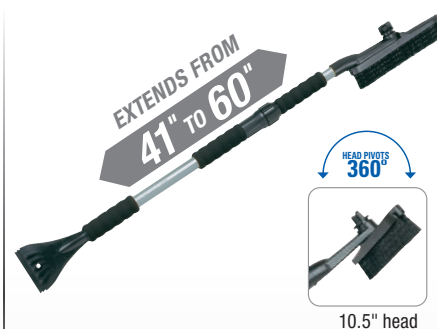

60" Monster™ Swivel Snowbroom

- 60" reach when fully extended
- Super heavy-duty steel tube for extended reach
- Extra wide blade for maximum ice removal

15781 - 8 pcs. Open Stock



52" Avalanche™ Extreme Snowbroom

- Wide broom head rotates 180 degrees and features non-scratch EVA foam
- Quick-Lock™ extender easily locks into desired length
- Large diameter, hammer tone finish pole, with rubber grips for ultimate control

14052 - 12 pcs. Tray Pack



51" Heavy-Duty Arctic Plow™ With Scraper

- Super wide 16+ inch push-pull foam head clears snow quickly and won't scratch paint
- Telescoping steel handle for extra reach
- 4" scraper blade on opposite end for quick ice removal

18833 - 8 pcs. Open Stock



46" Heavy-Duty Arctic Plow™ With Grip

- Super wide 16+ inch push-pull foam head clears snow quickly and won't scratch paint
- Telescoping steel handle for extra reach

18841 - 8 pcs. Open Stock
18847 - 10 pcs. Floor Display

CROSSOVER SNOWBROOMS™

THE CURVE CHANGES EVERYTHING

The Curved Pole Increases Leverage Across the Windshield Making Scraping Easier



50" Ultimate MAXX-Force™ Crossover Snowbroom™

- MAXX-Force™ offset ice chippers easily cut through thick ice
- Curved pole provides superior long reach scraping ability
- Pivoting triple-action broom head features EVA foam that works on light frost and water
- MAXX-Force™ blade contours to windshield for maximum scraping width

14185 - 12 pcs. Tray Pack



48" Ultimate Polar Vortex™ Crossover Snowbroom™

- Curved pole provides superior long reach scraping ability
- Broom head rotates 180° and features a squeegee
- Polar Vortex™ blade contours to windshield for maximum scraping width
- Extends from 30" - 48" to provide longer reach

14170 - Extends from 26" - 42" - 12 pcs. Tray Pack

14180 - Extends from 30" - 48" - 12 pcs. Tray Pack

QP48-14180 - 48 pcs. Quarter Pallet Floor Display



50" MAXX-Force™ Crossover Snowbroom™

- MAXX-Force™ offset ice chippers easily cut through thick ice
- Curved pole provides superior long reach scraping ability
- Pivoting brush head features long, flagged bristles to remove the deepest snow

14151 - 12 pcs. Tray Pack



50" Avalanche™ Crossover Snowbroom™

- Brush head rotates 360° for optimal snow removal
- The Quick-Lock™ Extender easily locks into the desired length
- Built-in ice chippers break up tough ice and the wide blade easily clears away any frost

14039 - 6 pcs. Tray Pack



35" Avalanche™ Crossover Snowbroom™

- Brush head rotates 360° for optimal snow removal
- The Quick-Lock™ extender easily locks into the desired length
- Built-in ice chippers break up tough ice and the wide blade easily clears away any frost

14035 - 6 pcs. Tray Pack



38" Avalanche™ Crossover Snowbroom™

- Brush head rotates 360° for optimal snow removal
- Built-in ice chippers break up tough ice and the wide blade easily clears away any frost

14038 - 6 pcs. Tray Pack

POWER FORCE™

GLACIER SNOWBROOMS

Advanced Multi-Function
Squeegee Seals Against
Glass, Removing All
Moisture with Ease

Super Dense, Long Bristles
Makes Removing Heavy
Snow a Breeze



THE POWER TO MAKE ICE DISAPPEAR

POWER-Force Series™

- 14462 - 62" Glacier™ Snowbroom - p. 144
- 14454 - 54" Snowbroom - p. 146
- 13060 - 44" Extending Snowbrush - p. 147
- 13030 - 34" Snowbrush - p. 149
- 13020 - 25" Snowbrush - p. 149
- 13050 - 11" Ice Scraper - p. 151





54" POWER-Force™ Snowbroom

- POWER-Force™ ice chippers easily cut through thick ice
- Pivoting broom head features rubber squeegee for easily removing moisture
- 4" chisel blade for frost/ice removal

14454 - 12 pcs. Tray Pack



54" Avalanche™ Pivoting Snowbroom

- Aggressive blade breaks through thick ice
- Added leverage positions for directing more pressure to the blade
- Heavy-duty pivoting broom + squeegee provides long reach for large vehicles
- Quick-Lock™ extender easily locks into desired length

14015 - 12 pcs. Tray Pack



54" Snow Plow™ Snowbroom

- Foam plow clears heavy snow
- Quick-Lock™ extender easily locks to desired length
- 4" Avalanche™ scraper blade for ice and frost removal

14403 - 12 pcs. Open Stock



52" Quick-Lock™ Pivoting Snowbroom

- Quick-Lock™ extension pole reaches 52"
- Extra wide scraper blade
- Pivoting soft bristle snowbroom and squeegee
- Great for trucks, SUVs and RVs

80052 - 6 pcs. 52" Open Stock



52" Pivot Head FORCE™ Sport Telebroom™

- Extends from 34" to 52" for maximum reach
- Pivoting broom head also features a rubber squeegee
- Contour foam grip provides ultimate comfort

583-EPRFB - 6 pcs. Open Stock

S12-583EPRFB - 12 pcs. Tray Pack

F12-583-EPRFB - 12 pcs Floor Stand



52" Extending FORCE™ Snowbroom

- Broom head rotates 360° to remove snow from any angle
- Twist-Lock™ extender easily locks into desired length
- 4" FORCE™ blade features offset ice chippers for maximum ice and frost removal

S24-582-EPSZFB - 24 pcs. Tray Pack

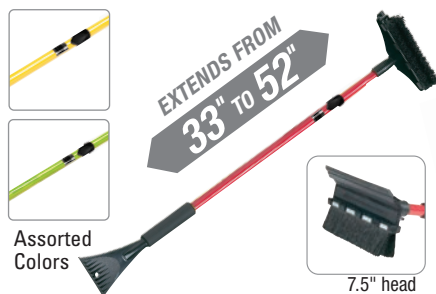

52" Super Extender Snowbroom

- Heavy-duty broom for snow clearing power
- Steel extender handle with soft cushion grip
- Extra wide blade on brush head with convenient removable squeegee

2610XM - 10 pcs. Open Stock



48" Sport FORCE™ Snowbroom

- Extends from 30" to 48" for added length and reach
- Barrel-lock allows for quick and easy length adjustments
- Easily pushes snow off of roof, hood and front windshield

581-EFB - 6 pcs. Open Stock

S12-581-EFB - 12 pcs. Tray Pack

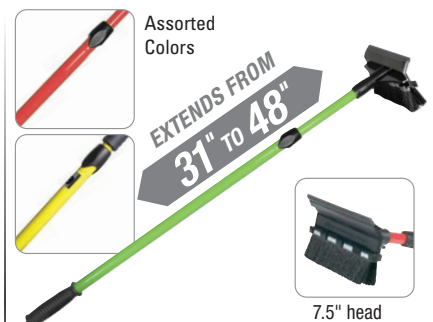

48" Extender Snowbroom

- Twist-Lock™ extender easily locks into desired length
- Wide blade and broom extend to 48"
- Great for larger vehicles

2610XB - 10 pcs. Open Stock

2610FD - 20 pcs. Floor Display



Assorted Colors

EXTENDS FROM 26" TO 35"

HEAD PIVOTS 180°

8.5" head

35" Mini Snow Plow™ Snowbroom

- Wide 8.5" sweeping area with tall head
- EVA foam squeegee clears light frost and water without scratching paint
- Twist-Lock™ extender easily locks into desired length

3512PBT - 12 pcs. Open Stock



Mallory

EXTENDS FROM 26" TO 35"

HEAD PIVOTS 180°

Assorted Colors

8" head

35" Mini Pivot Telebroom™

- Extends from 26" to 35" to provide a longer reach
- Pivoting broom head also features a rubber squeegee
- Barrel-lock allows for secure extension

580-EP - 6 pcs. Open Stock

F15-580-EP - 15 pcs. Floor Display

S12-580-EP - 12 pcs. Tray Pack



Assorted Colors

EXTENDS FROM 23" TO 35"



13.5" head

35" Mini Arctic Plow™ With Grip

- Clears deep and heavy snow
- No-scratch 13.5" foam head
- Long reach – yet small enough to store in any vehicle

18849 - 8 pcs. Open Stock

SNOWBRUSHES



Mallory

EXTENDS FROM 23" TO 36"



8" head

36" Mini Extender Snowbroom

- Extends from 23" to 36" to provide a longer reach
- Barrel-lock allows for quick and easy length adjustments
- Perfect for small to mid-size vehicles

511-E - 10 pcs. Open Stock

F16-511-E - 16 pcs. Floor Display

S16-511-E - 16 pcs. Tray Pack



EXTENDS FROM 21" TO 40"

ALPINE GEAR
PERFORMANCE FOLDING TOOLS



Folding lock

ALPINE GEAR™ 40" Folding Snowbrush

- Power Pivot™ Folding lock folds compact for easy storage
- Super duty construction
- Compact brush on the shelf that still provides desired long reach
- 40 inch long reach, compacts down to 21 inches for easy storage

14415 - 12 pcs. Open Stock

14416 - 12 pcs. Tray Pack



MAXX FORCE

37" MAXX-Force™ Snowbrush

- MAXX-Force™ offset ice chippers easily cut through thick ice
- Curved pole keeps hands out of the snow and makes removal easier
- XL brush head to clear deep snow

14135 - 12 pcs. Tray Pack



EXTENDS FROM 34" TO 44"

POWER

44" POWER-Force™ Telescopic Snowbrush

- POWER-Force™ ice chippers easily cut through thick ice
- Twist-Lock™ extension provides long reach from 34" to 44"
- Thick brush head for snow removal

13060 - 12 pcs. Tray Pack

DS60-13060 - 60 pcs. Floor Display



EXTENDS FROM 32" TO 42"

Assorted Colors

42" Ice Chisel® Telescopic Snowbrush

- Ice Chisel® scraper with 2-blades-in-1, ice chipping plus frost removal
- Twist-Lock™ extender easily locks into desired length
- Improved thicker brush head

13054 - 12 pcs. Open Stock

13059 - 12 pcs. Tray Pack

109-13056 - 60pcs Floor Display



35" Polar Vortex™ Ultra Maxx® Snowbrush

- Curved pole keeps hands out of the snow
- XL brush head to clear deep snow
- Polar Vortex™ blade contours to windshield for maximum scraping width

S8-999PV - 8pcs. Tray Pack

FORCE™

- Offset Chippers Cut Through Thick Ice
- Flat Compact blade design clears frost and ice with ease

USING THE FORCE HAS NEVER BEEN EASIER!



FORCE™ Series

12080

61" BLIZZARD FORCE™ Pivoting Snowbroom - p. 147

581-EFB

48" Sport FORCE™ Snowbroom - p. 150

583-EPRFB

52" Sport FORCE™ Pivot Head Telebroom - p. 150

S24-582-EPSZFB

52" Extending FORCE™ Snowbroom - p. 150

996-35FB

35" FORCE™ Snowbroom - p. 153

S24-530RFB

26" FORCE™ Snowbrush - p. 154

523FB

24" FORCE™ Snowbrush - p. 154

S18-518FB

17" FORCE™ Snowbrush - p. 154





Assorted Colors



35" Ultra MAXX® Snowbrush

- Five rows of bristles quickly remove deep snow
- Thick 1" lightweight aluminum pole for ease of use for all consumers
- Curved pole keeps hand out of snow

999CT - 6 pcs. Open Stock

F14-999CT - 14 pcs. Floor Display

S16-999CT - 16 pcs. Tray Pack

QP72-999CT - 72 pcs. Quarter Pallet



Assorted Colors



34" Mega MAXX™ Snowbrush

- Curved pole provides an ergonomic design making it easier to reach the middle of the windshield
- Lightweight aluminum pole is easy for any consumer to use
- Five rows of bristles quickly remove deep snow

989-34 - 6 pcs. Open Stock



34" POWER-Force™ Snowbrush

- POWER-Force™ ice chippers easily cut through thick ice
- Strong steel handle for increased durability
- Thick brush head for snow removal

13030 - 12 pcs. Tray Pack



35" Ice Crusher™ Snowbrush

- Dual action bristles provide soft protection and interior brushing power
- Separated ice chippers on the brush head break through the thickest ice
- Wide blade quickly removes frost

16620 - 12 pcs. Tray Pack



35" Avalanche™ Snowbrush

- Aggressive blade breaks through the thickest ice
- Added leverage positions allow application of more pressure to the blade
- Improved thicker brush head

14014 - 14 pcs. Tray Pack



Assorted Colors



35" FORCE™ Snowbrush

- FORCE™ blade ice chippers easily cut through thick ice
- Full brush head removes snow from hard to clear areas
- Lightweight aluminum pole allows for easy use for all consumers

996-35FB - 12 pcs. Open Stock (Force™ Blade)

S24-996-35 - 24 pcs. Tray Pack

S24-996-35FB - 24 pcs. Tray Pack

F24-996-35FB - 24 pcs. Floor Display

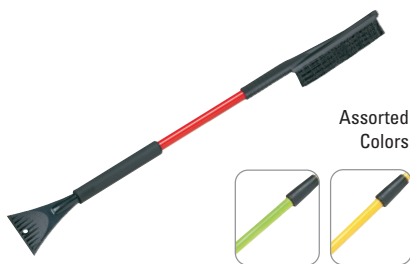

Assorted Colors



35" Blizzard™ Snowbrush

- Two rows of bristles quickly remove deep snow
- Contoured soft cushion grip
- Coated, heavy-duty handle

13781 - 14 pcs. Tray Pack

3518FD - 18 pcs. Floor Display



Assorted Colors



32" Ice Chisel® Snowbrush

- Two rows of bristles quickly remove deep snow
- Ice Chisel® scraper with 2-blades-in-1, ice chipping plus frost removal
- Strong handle with soft cushion grip

13024 - 12 pcs. Open Stock

13025 - 12 pcs. Tray Pack



25" POWER-Force™ Ergo Snowbrush

- POWER-Force™ ice chippers easily cut through thick ice
- Chisel blade for frost removal
- Thick brush head for snow removal
- Curved ergonomic body keeps hands out of snow

13020 - 24 pcs. Open Stock



23" Falcon™ Snowbrush

- Ergonomic rubber styling with non-slip grip
- Double row bristles remove heavy snow
- Quickly remove ice with patented 2-way, push-pull scraper design

15613 - 12 pcs. Tray Pack



26" Power Series™ Snowbrush

- Premium soft-touch rubber grip for ultimate comfort
- Dual grip zones improve leverage against thick ice
- Patented Duo reversible blade improves ergonomics from both sides of the vehicle

18520 -12 pcs. Tray Pack



26" Cool Snow Tool® Snowbrush

- Four rows of sturdy bristles provide a thick and full brush for snow removal
- Curved handle keeps hands out of snow
- Foam grip provides ultimate comfort

532 - 12 pcs. Open Stock
 S24-532 - 24 pcs. Tray Pack
 F20-532 - 20 pcs. Floor Display



26" FORCE™ Snowbrush

- FORCE™ blade ice chippers easily cut through thick ice
- Thick brush head for snow removal
- Curved handle keeps hand out of snow

S24-530RFB - 24 pcs Tray Pack
 530RFB - 18 pcs Open Stock
 S12-530RFB - 12 pcs Tray Pack



23" Ice Hammer™ Snowbrush

- Curved handle keeps hands out of snow
- Soft-molded grip repels water and withstands UV rays for longer life
- Built-in ice chippers break up tough ice

16511 - 8 pcs. Tray Pack



21.5" Ice Ripper™ Snowbrush

- Durable design encourages step-up sales
- Aggressive scraper blade
- Palm pad for increased leverage

16024 - 20 pcs. Tray Pack



17" FORCE™ Snowbrush

- FORCE™ blade ice chippers easily cut through thick ice
- Molded contour design for a better grip
- Thick durable bristles for clearing snow

S18-518FB - 18 pcs. Tray Pack
 518RFB - 18 pcs Open Stock



24" FORCE™ Snowbrush

- Molded contour grip for comfort
- Durable bristles to sweep snow off your vehicle
- FORCE™ blade ice chippers easily cut through thick ice

523FB - 24 pcs Open Stock
 S24-523FB - 24 pcs Tray Pack



22" Super Deluxe™ Snowbrush

- World's best selling snowbrush, often copied, but never duplicated
- 4" wide Bear Claw® blade
- Perfect for small to medium size passenger vehicles

19520 - 20 pcs. Tray Pack
 2248FD - 48 pcs. Floor Display



25" Valu Reach Sweep™ Wood Handle Snowbrush

- Constructed with high quality material for long lasting durability
- Strong ice scraper with ice chippers removes ice quickly and easily
- Popular among traditional consumers

203 - 24 pcs. Open Stock
 50-203- 50 pcs. Open Stock

ICE SCRAPERS



11" MAXX-Force™ Scraper

- MAXX-Force™ offset chippers easily cut through thick ice
- 4" wide Patented Flex Blade™ conforms to the glass
- Rubber grip for ultimate control

14125 - 18 pcs. Tray Pack
14126 - 18 pcs. Open Stock



11" Polar Vortex™ Scraper

- Polar Vortex™ blade contours to windshield for maximum scraping width
- Separate ice chippers to cut through thick ice
- Rubber grip for ultimate control

14120 - 18 pcs. Tray Pack
14120Y - 18 pcs. Tray Pack (Yellow)



11" POWER-Force™ Ice Scraper

- POWER-Force™ ice chippers easily cut through thick ice
- 4" chisel blade for frost removal
- Foam grip for comfort

13050 - 24 pcs. Tray Pack



11" Ice Crusher™ Scraper

- Two durable blades - one for frost, one for ice
- Extra wide 4.5" blade
- Foam grip for added comfort

16621 - 24 pcs. Tray Pack



11" Avalanche™ Ice Scraper

- Aggressive blade breaks through the thickest ice
- Added leverage positions allow application of more pressure to the blade
- Cushioned grip for comfortable scraping

14012 - 24 pcs. Tray Pack



10" Ice Chisel® Scraper

- Patented 2-blades-in-1 design, ice chipping plus frost removal
- 3.5" scraper blade
- Foam grip available in assorted colors

13014 - 12 pcs. Open Stock
13044 - 24 pcs. Tray Pack



11" Ice Ripper™ Scraper

- Built-in side chippers break through tough ice
- 4" wide blade easily clears away frost
- Flat, compact design, for easy storage

16250 - 24 pcs. Tray Pack



10" FORCE™ Ice Scraper

- FORCE™ blade ice chippers easily cut through tough ice
- 4" wide scraper blade for frost and ice removal
- Contour foam grip for comfort and control

S24-994RFB - 24 pcs. Tray Pack



11" Klondike™ Ice Scraper

- Flat, compact design for easy storage
- Oversized chippers for superior ice breaking power
- Wide 4" frost clearing blade

1124F - 24 pcs. Tray Pack



9" Ice Ripper™ Ergonomic Scraper

- Ergonomic, rounded handle for greater grip power and comfort
- Thumb pad allows application of more pressure to the blade

16211 - 24 pcs. Tray Pack



10" Bear Claw® Ice Scraper

- Flat, compact design, for easy storage
- Most popular OPP scraper
- Curved handle helps keep hand off windshield
- Wide 4" frost clearing blade

16721 - 24 pcs. Tray Pack



Premium Ice Scraper Mitt

- Quilted outer layer for exceptionally soft feel
- Durable scraper breaks through the toughest ice

13920 - 12 pcs. Tray Pack
13920CS - 12 pcs. Clip Strip
13929 - 12 pcs. Open Stock (Faux Fur)

ARCTIC DEFENSE™ WINDSHIELD COVERS



❄️ **Single Person Setup**

❄️ **Flex Anchors™ Secure Windshield Cover to Vehicle**



17545

ArcticDefense MAXX™ Windshield Cover

- Flex Anchors™ secure cover to windshield inside vehicle doors
- HD Canvas material
- Fits all vehicles (42" x 61")

17540 - 5 pcs. Tray Pack
17541 - 12 pcs. Floor Display
17545 - 6 pc. Open Stock (sleeved)



ArcticDefense™ Windshield Cover

- Flex Anchors™ secure cover to windshield inside vehicle doors
- Fits most vehicles (32" x 61")

17505 - 6 pcs. Tray Pack



ArcticGuard™ Truck Windshield Cover

- Fits almost all vehicles (40" x 73")
- Covers side-view mirrors
- Packaging footprint is significantly smaller than competitive covers

17529 - 6 pcs. Tray Pack



ArcticGuard™ Car Windshield Cover

- Folds compact for easy storage
- Packaging footprint is significantly smaller than competitive covers
- Size: (29" x 70")

17511 - 6 pcs. Tray Pack



Customizable 3-Piece Boot Tray

- 3 piece easy snap design for versatility
- Deep channel basins along the side for liquid run off
- Assembled tray dims 36.5" x 16" x 1"
- Great for in the vehicle, home, or garage

12555 - 6 pcs. Tray Pack

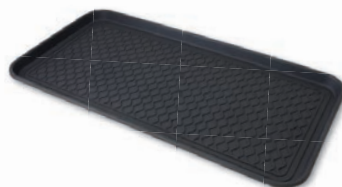

Boot Tray (15" x 30" x 1.15")

- Raised ridges allow footwear to thoroughly drip dry
- Easy to clean up
- Perfect accessory for any vehicle or home

12550 - 6 pcs. Open Stock



Ice Cleats™

- Aggressive spikes help prevent dangerous slips and falls
- One size fits most shoes
- Durable material for long lasting effectiveness

12201 - 6 pcs. Tray Pack



Heavy-Duty Aluminum Emergency Shovel

- Heavy-duty aluminum construction holds up to demanding jobs
- Extends to 30" for long reach
- Dual-function scoop or dig design

17222 - 6 pcs. Tray Pack
17222HT - 6 pcs. Open Stock



Auto Emergency Shovel

- Extends to 37" for long reach
- 9.5" wide shovel head
- Compact for easy storage when closed

17211 - 8 pcs. Tray Pack
17228 - 8 pcs. Floor Display
17297 - 8 pcs. Shovel/Scraper combo Floor Display



ALPINE GEAR™ 39" Foldable Auto Emergency Shovel

- Extends from 23" to 39" for long reach
- Dual function scoop or dig design
- 9 1/2" wide shovel head
- Power Pivot technology folds shovel compact for easy storage

17230 - 8pc Open Stock
17231 - 6pc Floor Display



GripTrax™ Maxx Traction Tool

- Flexible traction bars conform to all terrains
- 33" length folds compactly into provided storage bag
- Eliminates shoveling and pushing

12505 - 4 pcs. Tray Pack



GripTrax™ Traction Tool

- Place in front or behind tires for traction
- Designed to hold in place, won't fly out
- Works in snow, mud and sand

12501 - 4 pcs. Open Stock



HotSpot™ Hand Warmers

- Up to 10 hours of heat for Hand Warmers and 8 hours for Toe Warmers, activates in seconds
- Reaches temps up to 140°
- 2 warmers per pack
- Toe warmers include adhesive to keep in place

12324 - 24 pcs. Tray Pack



12V Heated Travel Blanket

- 57" x 39" super soft polyester
- High/Low heat setting
- 6.5' cord length for added reach to back seat

12620 - 6 pcs. Tray Pack



OXICLEAN™ Winter Salt Eraser

- Bi-level bristles utilize stiff sweeping fibers
- Cap incorporates spot scrubber and groove cleaning tool
- Great for carpet, floor mats, and fabrics
- 18.5 oz.

572100C - 6 pcs. Tray Pack



Lock De-Icer™ and Lubricant

- Thaws frozen locks
- Lubricates lock cylinder
- Works on locks, mail boxes, and shed doors

22-5-00500-SZ - 24 pcs. Tray Pack, 18.5 ml
22-5-00500-SZFB24 - 24 pcs. Fish Bowl, 18.5 ml
22-5-00500-SZCS12 - 12 pcs. Clip Strip, 18.5 ml
22-5-00502-SZ - 12 pcs. Tray Pack, 37ml Jumbo



NATIONAL
BREAST
CANCER
FOUNDATION, INC.®

SEE A BETTER ROAD AHEAD

A DONATION IS MADE FOR EVERY PINK PRODUCT SOLD



45" Telescopic Snowbroom

- Extends from 28" to 45" for increased reach
- Contour foam grip provides ultimate comfort
- Barrel-lock allows for quick and easy length adjustments

S12-577-EPKUS - 12 pcs. Tray Pack
D8 -577-EPKUS - 8 pcs. Display



31" Pink FORCE Snowbrush

- Innovative FORCE™ Blade pairs offset chippers with a flat compact blade design for quick and easy ice removal
- Thick, full brush for easy snow removal
- Lightweight aluminum pole provides ease of use for all consumers
- Contour foam grip provides added comfort and control

886PKCFB - Open Stock



31" Pink Snowbrush

- Strong ice scraper to remove frost and heavy ice
- Thick, full brush for easy snow removal
- Lightweight aluminum pole provides ease-of-use for all consumers

S30-886PKUS - 30 pcs. Tray Pack
D24-886PKUS - 24 pcs. Display



22" Pink Snowbrush

- Effective scraper cuts through frost and heavy ice
- Brush easily clears snow from all areas of the vehicle
- Compact size for effective storage

S24-527PKUS - 24 pcs. Tray Pack
DS58-3BHPKUS - 24 pcs. Floor Display



10" Pink Ice Scraper

- 4" blade removes frost and heavy ice
- Easy to store in any vehicle
- Contour foam grip provides ultimate comfort

994PKUS - 24 pcs. Tray Pack

WINTER TOOLS



800-524-1458

FLOOR DISPLAYS

Whether it's inside the front entrance or another key traffic location, floor displays create high impact display options

Part #	Description	# Pcs.
2248FD	22" Super Deluxe™ Snowbrush Floor Display	48 pcs.
2610FD	48" Extender Snowbroom Tee Pee Display	20 pcs.
3518FD	35" Blizzard™ Snowbrush Floor Display	18 pcs.
3648	22" Super Deluxe™ Snowbrush Floor Display	36 pcs.
	10" Bear Claw® Floor Display	48 pcs.
17228	Auto Emergency Shovel Floor Display	8 pcs.
17297	Auto Emergency Shovel with Bonus Ice Ripper™ Scrapper Floor Display	8 pcs.
18837	Arctic Plow™ with Scrapper Floor Display	10 pcs.
18847	Arctic Plow™ with Grip Floor Display	10 pcs.
F20-996-35	35" MAXX® X35	20 pcs.
F20-532	26" Cool Snow Tool®	20 pcs.
F24-523	24" Slimline 24	24 pcs.
F14-583-EP	52" Pivot Head Sport Tele Snowbroom	14 pcs.
F15-580-EP	35" Mini Pivot Tele Snowbroom	15 pcs.
F12-581-E	48" Sport 8 Utility Broom	12 pcs.
F16-511-E	36" Tele Snowbroom	16 pcs.
D8-577-EPKUS	45" Pink Telescopic Snowbroom	8 pcs.
D24-886PKUS	31" Pink Snowbrush	24 pcs.
DS58-2BPKUS	48 pcs. 886PKUS, 10 pcs. 577-EPKUS	58 pcs.
DS58-3BHPKUS	24 pcs. 886PKUS, 24 pcs. 527PKUS, 10 pcs. 577-EPKUS	58 pcs.
F14-999CT	14 pcs. 35" Ultra Maxx® Snowbrush	14 pcs.
17541	ArcticDefense MAXX™ Windshield Cover	12 pcs.
F24-996-35FB	35" FORCE X35 Snowbrush - Floor Display	24 pcs.
F24-530RFB	26" FORCE Snowbrush - Floor Stand	24 pcs.
F24-523FB	24" Slim-FORCE Snowbrush - Floor Stand	24 pcs.



17541



F24-996-35FB

SPINNER RACK DISPLAYS

Highly visible movable inventory that creates a category presence for retailers with limited shelf space

Part #	Description	# Pcs.
EDWR-6	2/3 Tier Empty Wire Spinner Rack	1 pcs.
SPINNER-4W	2 Tier Empty Wire Spinner Rack	1 pcs.
DWR5D	10" Bear Claw® Ice Scraper	24 pcs.
	11" Talon™ Ice Scraper	24 pcs.
	22" Super Deluxe™ Snowbrush	24 pcs.
	23" Ice Hammer™ Snowbrush	40 pcs.
	42" Ice Chisel® Telescopic Snowbrush	24 pcs.
DWR60A	35" Crossover Snowbroom	30 pcs.
	38" Crossover Snowbroom	30 pcs.
DWRBRUSH2	21.5" Ice Ripper™ Snowbrush	40 pcs.
	42" Ice Chisel® Telescopic Snowbrush	36 pcs.
	48" Extender Snowbroom	10 pcs.
	54" Klondike™ Pivoting Snowbroom	12 pcs.
DWR112	21.5" Ice Ripper™ Snowbrush	40 pcs.
	23" Falcon™ Snowbrush	24 pcs.
	10" Ice Chisel® Scraper	48 pcs.
DWR120	22" Super Deluxe™ Snowbrush	40 pcs.
	9" Ice Ripper™ Ergonomic Scraper	48 pcs.
	23" Ice Hammer™ Snowbrush	32 pcs.
DWR137	32" Ice Chisel™ Snowbrush	24 pcs.
	35" Mini Pivoting Snow Plow™	24 pcs.
	21.5" Ice Ripper™ Snowbrush	40 pcs.
	10" Ice Chisel® Scraper	48 pcs.
19230	11" PF Ice Scraper	24 pcs.
	25" PF Snowbrush	24 pcs.
	44" PF Extender S/Brush	12 pcs.
	54" PF Pivot Snowbroom	12 pcs.
817S2	Top Tier	
	10" Ice Scraper	24 pcs.
	17" Compact Snowbrush	18 pcs.
	26" Snowbrush	18 pcs.
	Bottom Tier	
	26" Snowbrush	6 pcs.
	35" X35 Snowbrush	24 pcs.
	44" PF Extender Brush	12 pcs.



19230



817S2



EDWR-6

PALLET DISPLAYS

Late November and December result in as much as 50% of your seasonal sales. Capture this heavy traffic and create holding power by capitalizing on these high volume promotional vehicles

Part #	Description	# Pcs.
QP72-999CT	35" Ultra MAXX® Snowbrush	72 pcs.
QP48-14180	48" Ultimate Polar Vortex™ Snowbroom	48 pcs.
1090800052	52" Quick-Lock™ Snowbroom	48 pcs.
1090130056	42" Twist-Lock™ Snowbrush	60 pcs.
DS72-532L	26" Cool Snow Tool® Snowbrush	72 pcs.
DS60-13060	44" Twist Lock POWER-FORce™ Snowbrush	60 pcs.
DS72-996-35FB	35" FORCE™ Snowbrush	72 pcs.

DS72-996-35FB



A man with a beard and mustache is looking at a black oil drain pan with a red funnel and a black extension tube. The man is on the left side of the frame, looking towards the right. The drain pan is on the right side of the frame, with a red funnel and a black extension tube. The background is a dark, industrial setting.

**BRING THE DRAIN
TO THE MESS**

THE RIGHT TOOL AT EVERY STEP™

INNOVATION LEADER

Continuous innovation is at the core of what we do. Within the FloTool® family of products runs a heritage of “firsts” that is driven by our commitment to improving the experience for DIY’ers

THE RIGHT BRAND FOR EVERY SHOPPER

The brand neutral FloTool® line of products are always compatible, regardless of the brand allegiance of your customer. Never lose a sale by having the wrong brand

THE RANGE OF PRODUCTS SHOPPERS ARE LOOKING FOR

Only FloTool® can tailor your planogram with opening price point items along with innovative step-up solutions that make vehicle maintenance easier for DIY’ers... keeping your customers satisfied and coming back for more





LIFTING OIL CHANGES TO THE HIGHEST STANDARD



Patented structural design combined with high strength, lightweight material makes the RhinoRamps® as strong as any other ramps on the market, resin or metal



Better by Design

Strength and stability - that was our goal. RhinoRamps® achieve this with a Strong as Steel™ superstructure and integrated Core-Trac™ non-skid feet to reduce sliding during use. Adding our superior tread pattern and wide design make these the most secure ramps on the market. A reduced rise angle also works to accommodate low profile vehicles... a feature most other ramps can't claim!

Space Saving and Lightweight

Our unique, nestable design not only saves space in the consumer's garage but more pieces on a pallet means reducing footprint in the warehouse, on the truck and minimizes space required on the retail shelf. This combined with our lightweight material allows for easy handling and portability making RhinoRamps® the best choice in lifting devices



RAMPS

PATENTED
Better by design

STRONGEST
The ONLY PASE
certified resin ramps

NESTABLE
Saves space
and money

LIGHTWEIGHT
Easier to handle



12,000 lb. GVW RhinoRamps®

- Nestable for maximum cube utilization
- 17 degree angle for low clearance vehicles
- Wide tire width
- Made in the USA

11909MI - 1 pair Open Stock



16,000 lb. GVW RhinoRamps Max®

- Nestable for maximum cube utilization
- 17 degree angle for low clearance vehicles
- Extra-wide tire width
- Made in the USA

11912MI - 1 pair Open Stock

CHOCKS



EZ Lift Rider Ramps™

- Makes mower maintenance easy
- Provides 6" of lift
- Gripping points for use on concrete or grass
- Made in the USA

11935MI - 4 pair Cut Case



Heavy-Duty Wheel Chocks™

- Safety device to use with ramps or other lifting devices
- Prevents tires from rolling
- Not for commercial use
- Made in the USA

11930MI - 4 pair Open Stock



Heavy-duty Chock and Block™

- Perfect for any boat trailer, RV, stock trailer, camper, etc.
- Prevents tires from rolling
- Made in the USA

11933MI - 6 pcs.

www.FloTool.com



GRIPTECH™

The No-Slip Wrench™

MAXIMUM GRIP WRENCHES

The GRIPTECH™ family of wrenches uses a non-slip grip that is superior to traditional oil change tools. This patented innovative grip allows the wrench to firmly grab the oil filter and remove it easily, quickly and without scrapes and bruises. Making the oil change easier can increase demand for DIY oil changes. That's exactly what GRIPTECH™ delivers.

WRENCHES

GRIPTECH



Swivel Handle Small Band Wrench

- Remove oil filters in hard to reach areas
- Fits oil filters 2 $\frac{7}{8}$ " to 3 $\frac{5}{16}$ " (73mm to 85mm) in diameter

10621GT - 6 pcs. Open Stock
10621GTPDQ - 6 pcs. Cut Case



GRIPTECH



Swivel Handle Medium Band Wrench

- Remove oil filters in hard to reach areas
- Fits oil filters 3 $\frac{3}{8}$ " to 3 $\frac{3}{4}$ " (85mm to 95mm) in diameter

10622GT - 6 pcs. Open Stock

GRIPTECH



Swivel Handle Large Band Wrench

- Remove oil filters in hard to reach areas
- Fits oil filters 3 $\frac{3}{4}$ " to 4 $\frac{5}{16}$ " (95mm to 110mm) in diameter

10634GT - 6 pcs. Open Stock

GRIPTECH



Swivel Handle Adjustable Band Wrench

- Accommodates four filter sizes in one
- Fits oil filters 2 $\frac{3}{4}$ " to 4 $\frac{1}{4}$ " (70mm to 108mm) in diameter

10620GT - 6 pcs. Open Stock

GRIPTECH



Jaw-Style Wrench

- Great for hard to reach filters
- Fits oil filters 2 $\frac{1}{4}$ " to 4" (70mm to 102mm) in diameter

10631GT - 6 pcs. Open Stock



Scan to see
GRIPTECH™
in action



Adjustable Chain Wrench

- Adjustable chain fits a wide range of oil filter sizes
- Fits oil filters 2½" to 4¾" (64mm to 112mm) in diameter

10633GT - 6 pcs. Open Stock



Adjustable 3-Prong Wrench

- Self adjusts to filter
- Fits oil filters 2¾" to 3¾" (60mm to 95mm) in diameter

10617GT - 6 pcs. Open Stock



Industrial Strength Rubber Strap Wrench

- Multiple automotive and household uses
- Fits objects up to 12" (304mm) in diameter

10632GT - 6 pcs. Open Stock



Heavy-Duty 3-Position Pliers

- Extra-long handles for hard to reach areas
- Fits oil filters 2½" to 4¾" (63mm to 108mm) in diameter

10627GT - 6 pcs. Open Stock
10627GTPDQ - 6 pcs. Cut Case



Nylon Strap Wrench

- Use with an adjustable wrench
- Removes filters up to 6" (152mm) in diameter

10619 - 6 pcs. Open Stock

EXTRACTORS



EXPERIENCE THE QUICKEST, CLEANEST & EASIEST OIL CHANGE!



EASE OF USE

Hand pump action creates a powerful vacuum for fluid extraction - no electricity needed!



COMPACT DESIGN

Allows for accessibility in tight spots and conveniently transfers fluids for storing, transporting and recycling



FLEXIBLE

A versatile lineup that is perfect for a variety of applications from large to small engine fluid services

Extraction allows oil and fluids to be removed through the dip stick port. The powerful vacuum combined with tubing extensions allows easy access to hard to reach places and eliminates the need to go under the vehicle



The Topsider's reliability, convenience, and versatility make it one of the top fluid removing systems in the marine and automotive aftermarket. This sturdy and well-built product will have you changing your own fluids for years to come



Topsider™ 8 Quart Fluid Extraction System

- A legend in the marine industry since 1985
- Durable steel construction
- Used oil and other liquids are stored safely for proper disposal
- Made in the USA

5060TS - 2 pcs. Open Stock

DO NOT USE WHILE BOAT IS IN MOTION



MADE IN USA
FROM RECYCLED MATERIALS



LiquiVac™ 8 Quart Fluid Extraction System

- 8 Quart capacity for large engines or multiple small engine changes
- No mess from spills or inconvenient drain plugs
- Used oil and other liquids are stored safely for proper disposal
- Made in the USA

2000LV - 3 pcs. Open Stock



LiquiVac™ 3 Quart Fluid Extraction System

- 3 Quart capacity is perfect size for small engine (4 cycle) oil changes
- No mess from spills or inconvenient drain plugs
- Used oil and other liquids are stored safely for proper disposal
- Made in the USA

2005LV - 3 pcs. Open Stock

DRAINS



MADE IN USA
FROM RECYCLED MATERIALS



SUPER DUTY

High Capacities and Leak-Proof Design Give Shoppers The Best DIY Drain Containers in the Market

LEAK PROOF

Eliminates the Mess

HIGH CAPACITY

Multiple Changes and Large Equipment

SPACE SAVING

Store Upright or Lay Flat

ROBUST HANDLES

Easy Transport and Handling



SUPER DUTY™

16 Quart Drain Container™

- Stores upright or flat without leaking
- Integrated handle and grip for easy carrying and handling
- Extended design captures the full stream of fluid - less mess
- Made in the USA

42003MI - 4 pcs. Open Stock
420032MI - 2 pcs. Open Stock



SUPER DUTY™

10 Quart Drain Container™

- Stores upright or flat without leaking
- Integrated corner hand grips for easy carrying and handling
- Extended design captures the full stream of fluid - less mess
- Made in the USA

42001MI - 6 pcs. Open Stock
420013MI - 3 pcs. Open Stock



SUPER DUTY™

24 Quart Drain Container™

- Deep recess reduces splatter - less mess
- Three ergonomic hand grips for easy transport
- Stores upright or flat without leaking
- Made in the USA

42004MI - 2 pcs. Open Stock



SUPER DUTY™

58 Quart Drain Container™

- Large capacity for multiple oil changes or commercial use
- Stores upright or flat without leaking
- Built-in wheels aid in maneuverability
- Made in the USA

42008MI - 1 pc. Open Stock



NEW

SUPER DUTY™

13 Quart Extender Drain Container

- Eliminate splatter by reducing distance
- Near-infinite height adjustment
- Introduces new higher end price point

42113MI - 3 pcs. Open Stock



NEW

8 Quart Drain Pan™

- Patient Pending decline spout for a focused pour stream.
- Larger catch radius
- Patient Pending oil filter rest prevents clogging during drainage
- Increase structural integrity

42108MI - 12 pcs. Open Stock

4210836MI- 36 pcs. Open Stock



Less Mess Drain Pan™

- Extended profile catches full fluid flow
- Great for anti-freeze applications
- Built-in filter drain stand
- Made in the USA

05080MI - 12 pcs. Open Stock



7 Quart Drain Pan™

- Built-in raised rim handles provide ease of use
- Drain scale helps track oil usage (1 to 7 quarts)
- Improved structural integrity
- Made in the USA

OP-1 - 36 pcs. Open Stock

OP-112 - 12 pcs. Open Stock



SUPER DUTY™

20 Quart Less Mess Drain Pan™

- Reduced splash
- Wider catch radius for large oil changes and radiator flushes
- Nestable design delivers more profit from less shelf space
- Made in the USA

42010MI - 10 pcs. Open Stock

RECYCLER



Dispos-Oil™

- 12 Quart capacity for multiple changes
- Container transports easily
- Molded handle and big mouth opening for easy carrying and pouring purposes

11849MI - 4 pcs. Open Stock



Large Drip Tray™

- Heavy gauge steel
- Large size - 25" x 36"
- No Spills, No Mess!™

DP-10 - 12 pcs. Open Stock

11430MI - 120 pcs. Pallet

TRANSPORT



6+ Gallon Water Can

- Six gallon, 64 ounce capacity
- Self-venting spout
- Top handle and back grip for easy carrying and pouring

50863MI - 4 pcs. Open Stock

HIGH-PERFORMANCE

fastest growing segment within "fill" products

QuickFill® Series funnels drive consumer satisfaction with performance features that DIYers value



MADE IN USA

FULFILLING CUSTOMERS' NEEDS

The diversity of the FloTool® funnel lineup is proven in delivering step-up opportunities and comp store growth

High-Performance

The ultimate funnel design puts best-in-class features to work to help the DIYer get the job done quickly and easily. Our high-performance funnels include "no-mess" splash guards, easy grip hand holds, speed channels and wide spout openings for high speed pouring. These funnels set the standard for fluid handling performance

Task-Specific

FloTool® continues to be the leader in developing high margin funnels that are specific to certain tasks, making fluid handling easier for the consumer. These include measuring and mixing, gasoline control, diesel exhaust fluid, transmission fluid and more. Task specific products generate increased revenue for you and higher satisfaction for the consumer

Multi-Purpose

Our multi-purpose funnels include unique step-up features such as the "no-mess" splash guard, bottle rests and flexible spouts to get to hard to reach filler holes. These middle price point items are key to product differentiation, offering balance and flexibility in your planogram

Basic Series

The FloTool® Basic Series of funnels provide essential fluid handling benefits at a value. Typically purchased by the budget-oriented consumer for smaller engine applications and general tasks, these funnels play a pivotal role in any "Good – Better – Best" product and pricing strategy



Giant QuickFill® Funnel

- Designed to hold large volume bottles
- Built-in hand hold for a better grip
- Filter screen included
- No-mess splash guard
- 8¾" wide x 12¼" tall

10705 - 6 pcs. Cut Case



Super QuickFill® Funnel

- Designed to hold one quart bottles
- Built-in hand hold for a better grip
- Extra wide neck for high-speed pouring
- No-mess splash guard

05062MI - 12 pcs. Open Stock

05062PDQMI - 12 pcs. Cut Case



QuickFill® Funnel

- Speed channels maximize flow rate
- Distinct hand hold for a better grip
- No-mess splash guard

10718 - 10 pcs. Cut Case

10718WR - 12 pcs. Off Shelf/Wire Ring

10718B/24 - 24 pcs. Open Stock

FUNNELS

TASK-SPECIFIC - engineered to do the job right



MADE IN USA

Diesel Exhaust Fluid DEF Funnel™

- Designed to fit all DEF filler holes
- Large basin and optimal angle to prevent leaking
- Speed channels maximize flow rate

10732WR - 10 pcs. Off Shelf/Wire Ring

10732PDQ - 10 pcs. Cut Case



Measu Funnel™

- Measures and pours
- On/off spout with tube and cap
- Improved handling
- Perfect for hard-to-reach filler ports

10704 - 6 pcs. Cut Case



Gas Gauge Funnel™

- Floating indicator signals when gas tank is full, helps prevent spills and overfills
- Great for lawn mowers and more
- No-mess splash guard

10711 - 6 pcs. Cut Case



Tight Spot Funnel™

- Pliable material conforms to space
- Ideal for tight engine compartments
- Molded hand-holds for a better grip

10716PDQ10 - 10 pcs. Cut Case

10716WR - 12 pcs. Off Shelf/Wire Ring



Super Trio Funnel

- Super QuickFill®, Multi-Purpose™, and Radiator Funnel™ combo
- Features no-mess splash guard
- Prevents fluid cross contamination
- Covers wide range of fluid applications

10714MX3 - 6 pcs. Cut Case



Capless Gas Tank Funnel™

- For adding fuel additives or gas from portable containers to capless and restricted fuel fillers/tanks
- Flat spot allows use with CARB Compliant Spouts

10719 - 12 pcs. Clip Strip

10719PDQ5 - 5 pcs. Cut Case



Locking Oil Funnel™

- Lock-in oil filler hole
- Funnel holds bottle while pouring
- No waste and no-mess quick pouring

10709 - 6 pcs. Cut Case

10709WR - 6 pcs. Off Shelf/Wire Ring



Transmission Funnel

- 18" funnel made from durable copolymer plastic
- Designed for hard-to-reach fluid-filling applications
- Perfect for transmission fluid

06064MI - 12 pcs. Open Stock



Radiator Funnel™

- Locks in most radiators
- No-mess splash guard
- Wide opening for quick pouring

10703 - 12 pcs. Cut Case

10703WR - 12 pcs. Off Shelf/ Wire Ring

MULTI-PURPOSE - innovative features step shoppers up



Multi-Task 5-in-1 Funnel™

- Holds one quart oil bottle
- Three interchangeable spouts, including the Flexi-Spout™
- Patented nestable design

10710WR - 6 pcs. Off Shelf/Wire Ring



Super Multi-Purpose™ Funnel

- Large size (18") for multiple applications
- Perfect for transmissions and other engine fluids
- High perceived value allows for higher retail price points

10712WR - 12 pcs. Off Shelf/Wire Ring
10712MXPW - 20 pcs. Sidekick
10712PDQ - 12 pcs. Cut Case



3-in-1 Flex Funnel™

- Ideal for hard to reach applications
- Distinct hand holds for a better grip
- Detachable flexible spout

05060MI - 12 pcs. Open Stock



2-Piece Funnel Set

- Multi-Purpose™ and Radiator Funnel™ combo
- No-mess splash guards
- Covers all general purpose fluid applications

10701MX2 - 12 pcs. Open Stock



Flex Pour/Funnel

- A multi-purpose funnel with detachable flexible spout
- 11" Flexible spout is threaded to screw onto most oil containers
- 1.5 Qt. (1.4 L)

10733 - 10 pcs. Open Stock

BASIC



Multi-Purpose Funnel™

- No-mess splash guard
- Fits all sizes of filler tubes
- Extended filler neck opens gas tank trap door

10701 - 12 pcs. Cut Case
10701WR - 12 pcs. Off Shelf/Wire Ring
10701MXPW - 40 pcs. Sidekick



Big Mouth Funnel™

- No-mess splash guard
- Wide opening for quick pouring
- Notched bottle rest

10713 - 12 pcs. Cut Case



Extra Large Funnel

- All purpose 18" funnel
- Great for hard to reach applications
- Tapered spout easily fits small openings

05034MI - 12 pcs. Cut Case



General Purpose Funnel

- **05007MI** - 72 pcs. Small Funnel, 1/2 pint (Gray)
- **05015MI** - 72 pcs. Medium Funnel, 1 pint (Charcoal)
- **05064MI** - 12 pcs. Large Funnel, 2 QT (Black)
- **05068MI** - 12 pcs. Funnel Set (3) (Small, Medium & Large)

SPOUTS



Transmission Fluid/Gear Oil Spout

- On/off adjustable flow spout
- Reduced tip for transmission filler tubes
- Fits quarts or gallons

10106B/6 - 6 pcs. Cut Case
10106WB - 12 pcs. Off Shelf/Wire Basket



Anti-Freeze/Windshield Washer Spout

- On/off valve
- Adjustable flow
- No Spills, No Mess!™

10101B/12 - 12 pcs. Open Stock
10101WB - 18 pcs. Off Shelf/Wire Basket



No Spill Oil Spout™

- Great for quart bottles
- No Spills, No Mess!™
- Adjustable built-in valve

10107B/12 - 12 pcs. Open Stock
10107WB - 18 pcs. Off Shelf/Wire Basket



Super Flexi-Spout™

- Works great for hard to reach areas
- Dual threading fits most quart and gallon containers
- Perfect for adding motor oil, anti-freeze, transmission and windshield washer fluid

10119B/24 - 24 pcs. Cut Case



MixMaster™ Injector

- Measure and mix only what is needed
- Complete with extension tube
- Ratio scale for exact measuring

10111/6 - 6 pcs. Open Stock
10111X/6 - 6 pcs. Off Shelf/Clip Strip

SIPHONS/PUMPS

MAKES FLUID TRANSFER QUICK AND EASY

Battery Operated Siphon Pump™

- Pumps 7 quarts of liquid per minute
- Pumps light fluids including gas, diesel, kerosene, anti-freeze, water and other non-corrosive liquids; *not for use with oils*
- Extended reach with 13" suction pipe
- 24" transfer tubing

10810 - 3 pcs. (Boxed) Open Stock



Multi-Purpose Transfer Pump™

- Easily siphons or pumps any liquid
- Can be used as an air pump or blower
- Perfect for any gas can or fluid set

10803 - 6 pcs. Open Stock
10803PDQ - 6 pcs. Cut Case



5 Gallon Pail Pump

- Easily transfer fluids from 5 gallon pails
- Equipped with heavy-duty 22" tube
- Clamp holds pump in place for ease of use

10804 - 3 pcs. Open Stock (Carded Poly bag)
10804/4 - 4 pcs. Open Stock (Boxed)



Shaker Siphon™

- Moves up to 3.5 gallons a minute
- 6 foot anti-static tube
- Perfect for home, auto, ranch, marine or farm

10801 - 6 pcs. Open Stock



Economy Siphon™

- 6 foot tube provides length for most jobs
- Easily transfers fluids
- Perfect for the budget oriented consumer

10802 - 6 pcs. Open Stock



Super Siphon™

- Clear tube to view liquid flow
- Safe and easy to use
- Perfect for transferring all types of liquids
- 6 feet long

10800/6 - 6 pcs. Open Stock
10800X/6 - 6 pcs. Off Shelf

PORTABLE FUEL FILTERS

YOUR TOOL FOR PURE FUEL

Dirt and water are the top reasons for fuel related engine failure

DIRTY FUEL IN PURE FUEL OUT

Pure Fuel Makes Any Engine Run Better and Last Longer

Dirt and water are practically unavoidable in stored fuel, causing corrosive acids, electrolysis, rust and more. These contaminants can plug filters, corrode components, decrease efficient combustion and cause engine shutdown or system failure

You can combat these problems by refueling with a Portable Fuel Filter. Protect your engine by using this innovative product every time you transfer fuel to your tank

SCAN HERE
To See The Fuel Filter In Action



Works With Gasoline, Diesel, Heating Oil and Kerosene

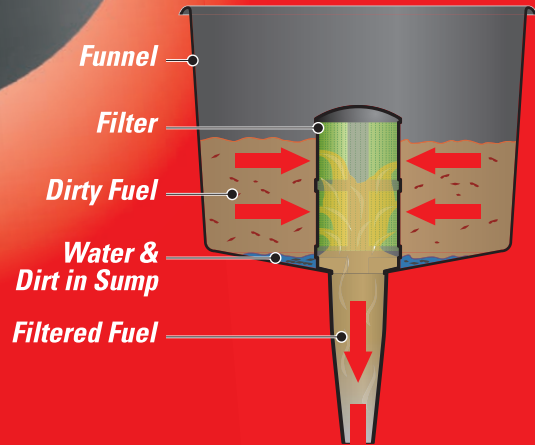

CHOOSE THE PORTABLE FUEL FILTER WITH THE FLOW RATE BEST SUITED TO YOUR CUSTOMERS' USE

FILTER	AGRICULTURE	INDUSTRIAL	MARINE	RECREATION	LAWN	GENERATOR
F15						
F8						
F3						
F1						



12" Flexible Spout

- Fill fuel at any angle
- Use with medium fuel filter funnels (F3 models) only

E3 - 12 pcs. Open Stock
ZE3 - 12 pcs. Bulk Open Stock



UNIQUE FILTER TECHNOLOGY

When fuel is poured through a Portable Fuel Filter, water and debris will not pass through the filter's fluoropolymer-coated stainless steel filter. Only filtered fuel flows through to your engine, improving its efficiency, durability and proper operation. The sump area collects the deflected water and debris for proper disposal



High Rate Conductive Portable Fuel Filter

Flow Rate - 12 Gallons per minute
Diameter - 8.5 Inches
Height - 10 Inches

F15C - 4 pcs. Open Stock



Large Conductive Portable Fuel Filter

Flow Rate - 5 Gallons per minute
Diameter - 8.5 Inches
Height - 10 Inches

F8C - 6 pcs. Open Stock



Medium Non-Conductive Portable Fuel Filter

Flow Rate - 3.5 Gallons per minute
Diameter - 5.5 Inches
Height - 9 Inches

F3NC - 12 pcs. Open Stock



Medium Conductive Portable Fuel Filter

Flow Rate - 3.5 Gallons per minute
Diameter - 5.5 Inches
Height - 9 Inches

F3C - 12 pcs. Open Stock



Small Conductive Portable Fuel Filter

Flow Rate - 2.5 Gallons per minute
Diameter - 3.5 Inches
Height - 6 Inches

F1C - 12 pcs. Open Stock



Small Non-Conductive Portable Fuel Filter

Flow Rate - 2.5 Gallons per minute
Diameter - 3.5 Inches
Height - 6 Inches

F1NC - 12 pcs. Open Stock

ABSORBENTS

CLEAN WITH CONFIDENCE

Keeping a floor clear of spills and slickness is essential, whether it is in the commercial or DIY setting. A high quality absorbent such as FloTool® High Performance Absorbent™ will quickly stop the spread of spills, and a Mallory® floor squeegee will make clean-up a breeze. Choose from commercial-grade oil resistant blades, to general-purpose blades, to foam blades, great on smooth surfaces

*Whatever the surface, whatever the fluid,
Mallory® floor squeegees get the job done right!*





High Performance Absorbent™ - 3 lbs.

- Resealable bag for small spills
- Instant one step clean-up
- Safer than traditional absorbents

10200 - 8 pcs. Open Stock



High Performance Absorbent™ - 3 oz.

- Convenient trial size bag for small spills
- Instant one step clean-up
- Safer than traditional absorbents

10202PDQ12 - 12 pcs. Cut Case

10202 - 12 pcs. Off Shelf/Clip Strip



Absorb More For Less

FloTool® High Performance Absorbent™ can absorb up to 8 times more liquid than traditional absorbents. The secret is how we heat-treat our wood fibers. It makes them far more effective than traditional clay and diatomaceous earth products. That's why FloTool® High Performance Absorbent™ is the best value for the consumer. Our absorbent can be used on oil, grease, lubricant, paint, water, and other fluids and is safe to use on most surfaces including concrete, blacktop, turf, carpet, linoleum, tile, and more.



SCAN HERE
See The
Difference

FLOOR SQUEEGEES

COMMERCIAL GRADE (Oil Resistant)

These oil-resistant rubber blades have a higher tolerance to oil and other chemicals resulting in a longer blade life

GENERAL PURPOSE

These general-purpose rubber blades work on all surfaces and with all fluids, perfect for the DIYer

FOAM

A foam blade is ideal for smooth surfaces such as decks, patios, driveways, sidewalks and ceramic floors

	KITS			HEADS ONLY		
	Part #	Description	Pcs.	Part #	Description	Pcs.
COMMERCIAL GRADE	841-24-116	24" Straight Red	2 pcs.	841-24	24" Straight Red	1 pc.
				841-30	30" Straight Red	1 pc.
				841-36	36" Straight Red	1 pc.
	844-30-116	30" Curved Red	2 pcs.	844-24	24" Curved Red	1 pc.
				844-30	30" Curved Red	1 pc.
				844-36	36" Curved Red	1 pc.
GENERAL PURPOSE	840-24-116	24" Straight Gray	2 pcs.	840-24	24" Straight Gray	1 pc.
				840-30	30" Straight Gray	1 pc.
				840-36	36" Straight Gray	1 pc.
	843-24-116	24" Curved Gray	2 pcs.	843-24	24" Curved Gray	1 pc.
				843-30	30" Curved Gray	1 pc.
				843-36	36" Curved Gray	1 pc.
FOAM	845-24-46	24" Straight	4 pcs.	845-24	24" Straight	4 pcs.
	846-30-54	30" Straight	3 pcs.	846-30	30" Straight	4 pcs.

KITS

Top selling heads complete with handles make it easy for consumers to shop the planogram



HEADS ONLY

- Thick, pliable, non-marking rubber blades with industrial-grade stamped steel sockets
- Thick foam blades with zinc-plated steel heads and adjustable handle socket

BLADE REFILLS

- 24" and 36" rubber refill blades
- Not available as a separate part for foam

HANDLES ONLY

- 54" hardwood handle with tapered tip
- 46" vinyl-coated steel handle with grip
- 54" vinyl-coated steel handle with grip and plastic threaded tip



BLADE REFILLS

HANDLES ONLY

Part #	Description	Pcs.	Part #	Description	Pcs.
841R-24	24" Red	10 pcs.	116	54" Wooden Handles	10 pcs.
841R-36	36" Red	10 pcs.	116	54" Wooden Handles	10 pcs.
840R-24	24" Gray	10 pcs.	130-46 Blue	46" Vinyl Coated Handle	10 pcs.
840R-36	36" Gray	10 pcs.	154 Black	54" Vinyl Coated Handle	10 pcs.
Not Available for Foam					

MERCHANDISERS

OFF SHELF / WIRE FIXTURES

Adding an extra ring or basket in the automotive set can increase sales by 20%

Part #	Description	Attachment	Pcs.
10101WB	Anti-Freeze/Windshield Washer Spout	Wire Basket	18 pcs.
10106WB	Trans Fluid/Gear Oil Spout	Wire Basket	12 pcs.
10107WB	No Spill Oil Spout™	Wire Basket	18 pcs.
10701WR	Multi-Purpose Funnel™	Wire Ring	12 pcs.
10703WR	Radiator Funnel™	Wire Ring	12 pcs.
10709WR	Locking Oil Funnel™	Wire Ring	6 pcs.
10710WR	Multi-Task 5-in-1 Funnel™	Wire Ring	6 pcs.
10712WR	Super Multi-Purpose Funnel™	Wire Ring	12 pcs.
10716WR	Tight Spot Funnel™	Wire Ring	12 pcs.
10718WR	QuickFill® Funnel	Wire Ring	12 pcs.

10106WB



10718WR



OFF SHELF / CLIP STRIPS

Increase sales with clip-strips during key promotional seasons

Part #	Description	Pcs.
10800X/6	Super Siphon™	6 pcs.
10111X/6	MixMaster™ Injector	6 pcs.
10719	Capless Gas Tank Funnel™	12 pcs.
10732WR	Diesel Exhaust Fluid (DEF) Funnel™	10 pcs.



10800X/6

FLOOR DISPLAYS

Multiple Configurations

Speak to your rep for more information



CUT CASES

Organize your planogram and boost holding power

Part #	Description	Pcs.
05034MI	Extra Large Funnel	12 pcs.
10106B/6	Transmission Fluid/Gear Oil Spout	6 pcs.
10119B/24	Super Flexi-Spout™	24 pcs.
10701	Multi-Purpose Funnel™	12 pcs.
10701MX2	2-Piece Funnel Set	12 pcs.
10703	Radiator Funnel™	12 pcs.
10704	Measu-Funnel™	6 pcs.
10705	Giant QuickFill® Funnel	6 pcs.
10709	Locking Oil Funnel™	6 pcs.
10710WR	Multi-Task 5-in-1 Funnel™	6 pcs.
10711	Gas Gauge Funnel™	6 pcs.
10712PDQ	Super Multi-Purpose Funnel™	12 pcs.
10713	Big Mouth Funnel™	12 pcs.
10714MX3	Super Trio Funnel™	6 pcs.
10716PDQ	Tight Spot Funnel™	18 pcs.
10718	QuickFill® Funnel	10 pcs.
10719PDQ5	Capless Gas Tank Funnel™	5 pcs.
10732PDQ	Diesel Exhaust Fluid (DEF) Funnel™	10 pcs.
10202PDQ12	High Performance Absorbent™, 3 oz. Bag	12 pcs.
11935MI	Easy Lift Rider Ramps™	4 sets



10712PDQ



10701



10719PDQ5

SIDEKICKS

Add a sidekick during key promotional periods and increase sales by 40%

Part #	Description	Pcs.
10701MXPW	Multi-Purpose Funnel™	40 pcs.
10712MXPW	Super Multi-Purpose Funnel™	20 pcs.



10701MXPW

OBSSESSED WITH PERFORMANCE

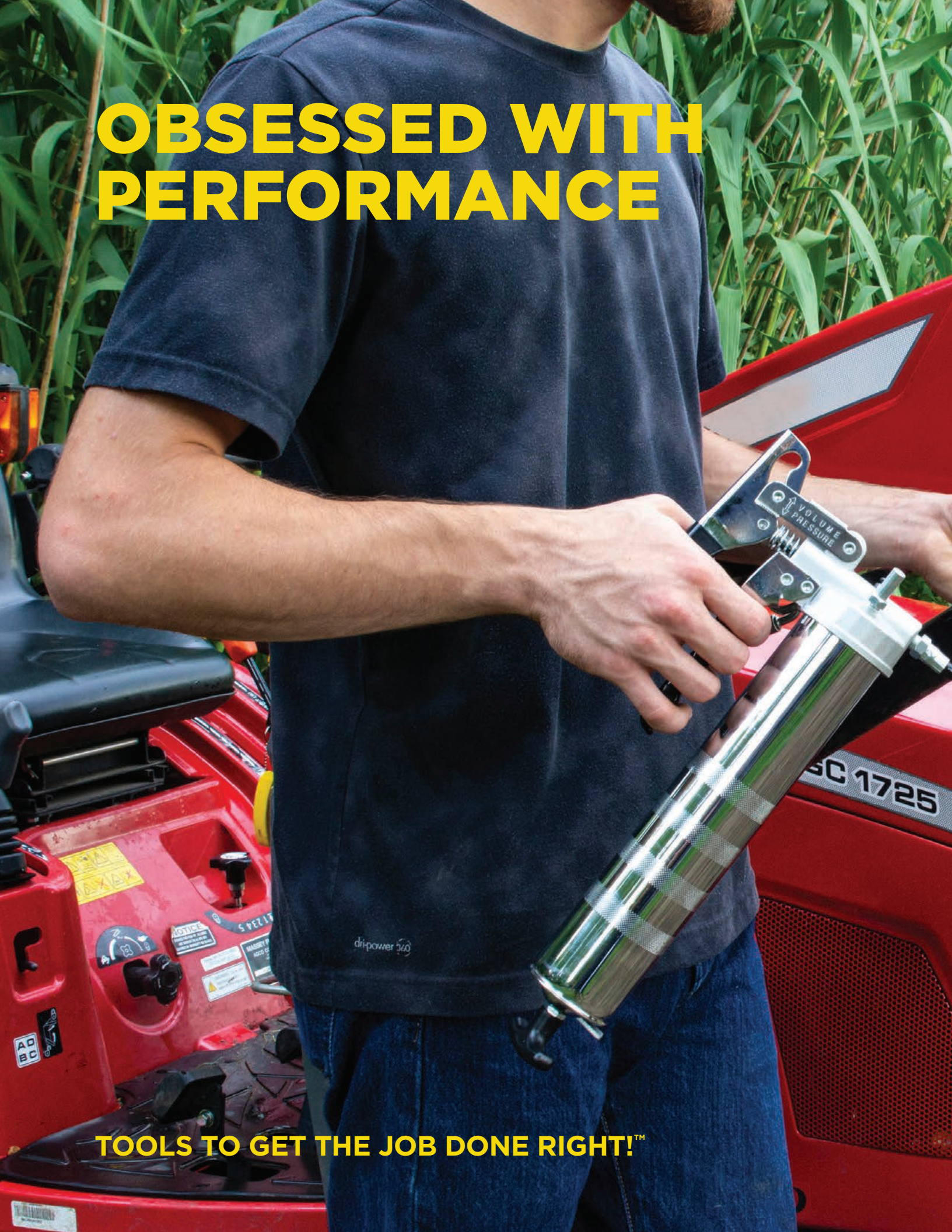

TOOLS TO GET THE JOB DONE RIGHT!™

PRECISION ENGINEERING

The Lumax® name has become synonymous with precision engineering. Our meticulous attention to every detail means our products are built for heavy-duty service, while making tasks easier and faster

BUILT TO LAST

We pride ourselves on building the most durable, long-lasting tools on the market. Details like our double-wall construction and fluted head deliver the best performance over the long haul

TURN-KEY PROGRAM

Our complete assortment of grease guns spans the full range of applications and price points that planograms require. Our grease gun accessories include all the couplers, zirks and hoses your customers need to keep their equipment up and running

LUMAX™
UNCOMPROMISING QUALITY



GREASE GUNS

RELENTLESS PRECISION

BETTER GREASE GUNS

More Grease per Stroke Maximum Grease Control

CONTOUR HANDLE
Saves Your Knuckles

COMPOUND LEVERAGE
For Less Effort

4 HARDENED JAWS
Holds a Stronger Connection

CHROME PLATED
For Corrosion Resistant

Heavy Duty, Premium Lever Grease Gun

- Cast-alloy head for extra strength
- Anti-corrosive chrome-plated finish
- 10,000 PSI
- Air Bleeder valve
- Includes filler nipple for use with grease filler pump LX-1302.

LX-1142 - 12 pcs. Open Stock

LEVER ACTION



Utility Lever Grease Gun

- Great performance at economical price
- 10,000 PSI
- Slip-resistant handle grip

LX-1100 - 12 pcs. Open Stock



Heavy-Duty, Deluxe Lever Grease Gun

- 10,000 PSI
- Short-stroke valve- maintains pressure with less effort
- Air bleeder valve
- Includes filler nipple for use with grease filler pump LX-1302.

LX-1120 - 12 pcs. Open Stock



Deluxe Lever Grease Gun

- Includes 18" Flex Hose and coupler for hard-to-reach fittings
- Heavy duty follower spring for consistent priming
- 10,000 PSI
- Air Bleeder valve
- Includes filler nipple for use with grease filler pump LX-1302.

LX-1123 - 12 pcs. Open Stock



Standard Lever Grease Gun

- Heavy gauge steel barrel for durability
- Contoured lever yields more pressure with less effort
- 10,000 PSI
- Air Bleeder valve

LX-1112 - 12 pcs. Open Stock

One Hand Control for Ease of Use

AIR OPERATED



Continuous Cycle, Air Operated Grease Gun

- Includes 30" high pressure hose for hard-to-reach fittings
- Designed for comfort and convenience of one-hand operation
- 6,000 PSI

LX-1161 - 2 pcs. Open Stock



Single-Shot, Air Operated Grease Gun

- Includes extension pipe and coupler
- Designed for comfort and convenience of one-hand operation
- 3,000PSI

LX-1160 - 12 pcs. Open Stock

PISTOL-GRIP



Heavy Duty, Deluxe Pistol Grease Gun

- Includes 18" flex hose for hard-to-reach fittings
- Convenient one-hand operation
- 7,000 PSI
- Air bleeder valve
- Includes filler nipple for use with grease filler pump LX-1302.

LX-1152 - 12 pcs. Open Stock



Mini-Pistol Grip Grease Gun with Cartridge

- Includes 3oz grease cartridge
- Compact and light weight
- Non-drip seal on grease coupler to prevent leaking
- Lithium based NLGI #2 grease

LX-1172 - 10 pcs. Open Stock

LX-1901 - 3 oz. Cartridge, 3 pcs./Pk.

LX-1900 - Single 3 oz. Cartridge
12 pcs.-Open Stock



Heavy Duty, Premium Pistol Grease Gun

- Includes 18" high pressure hose for hard-to-reach fittings
- Dual leverage feature for choice of high pressure or high volume
- Up to 8,500 PSI
- Air bleeder valve
- Includes filler nipple for use with grease filler pump LX-1302.

LX-1153 - 12 pcs. Open Stock



Deluxe Pistol Grease Gun

- Includes 4" rigid pipe
- Convenient one-hand operation
- 7,000 PSI
- Air bleeder valve
- Includes filler nipple for use with grease filler pump LX-1302.

LX-1150 - 12 pcs. Open Stock

OTHER



Heavy-Duty, Suction Gun (18 oz. / 510g) with 12" Flex Hose

- Excellent for draining and filling differentials, transmissions, clutches gear cases, etc.
- 18 Oz. (1 Pint / 510g) fluid capacity with 10" (250mm) stroke
- Needs no priming

LX-1185 - 12 pcs. Open Stock



Push-Lube Grease Gun

- Multi-functional
- One-hand operation
- Transparent body for visual control of fill level

LX-1174 - 10 pcs. Open Stock



GREASE GUN ACCESSORIES



Single-Hand Operation

Installation

Removal



COUPLERS



Heavy-Duty Quick Release Grease Coupler

- Locks-on and creates a leak-proof seal
- Hardened 4-jaws withstands high pressures without deformation
- Non-Return valve enables unit to be disconnected easily at pressures up to 15,000 PSI
- 2.9" for ideal for small, tight spaces

LX-1403 - 10 pcs. Open Stock



Extended Heavy-Duty Quick Release Grease Coupler

- Locks-on and creates a leak-proof seal
- Ideal for recessed and hard-to-reach fittings
- Non-return valve enables unit to be disconnected easily at pressures up to 15,000 psi
- 5" for ideal for small, tight spaces

LX-1403-XL - 10 pcs. Open Stock



Quick Release Coupler Counter Display

- Heavy-Duty Metal Counter Display
- 1 Coupler of each model Quick-Release Grease Coupler in Spring Guard grease hose for demo

LX-4851 - 1 pc. Open Stock 20 pcs. of each coupler (LX-1403 & LX-1403-XL)

LX-4851-3010 - 1 pc. Open Stock 30 pcs. of LX-1403 and 10 pcs. of LX-1403-XL



Right Angled Grease Coupler

- Designed for 90° access onto grease fittings
- Slips/slides onto grease fitting from side
- Features a positive lock-on style that ensures grease goes where you want it to

LX-1407 - 10 pcs. Open Stock



90° Grease Coupler

- For hard-to-reach grease fittings on cars, trucks, farm equipment
- Spring-loaded sleeve locks coupler in place for angular application
- 3000 PSI working pressure

LX-1404 - 10 pcs. Open Stock



Standard Grease Coupler

- Designed for use with all hand, air and battery powered equipment
- 4500 PSI

LX-1400 - 10 pcs. Open Stock

LX-1400-2 - 10 pcs. Open Stock - 2 pcs./pk

LX-1400-6 - 10 pcs. Open Stock - 6 pcs./pk

LX-1400-60 - 60 pcs. Open Stock



360° Swivel Grease Coupler

- Swivels in a full 360° circle and locks in place
- 45° Angle gives easy access to most grease fittings
- 3000 PSI working pressure

LX-1406 - 10 pcs. Open Stock



Heavy-Duty Grease Coupler

- For use with hand, air and battery operated grease guns
- Built-in check valve prevents leak, pressure loss and lubricant backup
- 7500 PSI

LX-1402 - 10 pcs. Open Stock



Grease Coupler with Hex

- For use with hand, air and battery operated grease guns
- Hex body for easy installation and removal
- 6000 PSI

LX-1401 - 10 pcs. Open Stock

AIR OPERATED GREASE GUN HOSES



Grease Hose 30" with 2 Spring Guards

- Push-Pull grip and prevents accidental kinking
 - 1/8" NPT x 7/16"-28 UNEF
 - 10000 PSI
- LX-1214** - 1 pc. Open Stock



Grease Hose 30" with 2 Spring Guards

- Push-Pull grip and prevents accidental kinking
 - 1/8" NPT x 3/8-32 UNEF
 - 7500 PSI
- LX-1212** - 1 pc. Open Stock



Grease Hose 18" with Spring Guards

- Push-Pull grip and prevents accidental kinking
 - 1/8" NPT x 3/8-32 UNEF
 - 7500 PSI
- LX-1211** - 1 pc. Open Stock

MANUAL GREASE GUN HOSES



Grease Hose 18" with Spring Guard

- Both Ends have Heavy-Duty, 1/8" NPT Male Threads Fittings
 - 1/8" NPT
 - 7500 PSI
- LX-1209** - 1 pc. Open Stock



Grease Hose 18" with Spring Guard

- Both Ends have Heavy-Duty, 1/8" NPT Male Threads Fittings
 - 1/8" NPT
 - 4500 PSI
- LX-1207** - 10 pcs. Open Stock
LX-1207-C - 24 pcs. Open Stock



Grease Hose 12" with Spring Guard

- Both Ends have Heavy-Duty, 1/8" NPT Male Threads Fittings
 - 1/8" NPT
 - 4500 PSI
- LX-1205** - 10 pcs. Open Stock



Grease Hose

- Both Ends have Heavy-Duty, 1/8" NPT Male Threads Fittings
 - 1/8" NPT
 - 4500 PSI
- 12" - LX-1201** - 10 pcs. Open Stock
18" - LX-1203 - 10 pcs. Open Stock

GREASE GUN ACCESSORIES



Grease Injector Needle

- Ideal for lubricating in very tight places like sealed bearings and universal joints
 - Snaps into any grease coupler
 - Comes with protective plastic cover
- LX-1416** - 10 pcs. Open Stock



Grease Gun Filler Nipple

- For use to bulk fill hand grease guns
 - 1/8" NPT male threads
 - For use with Lumax® LX-1302 Filler Pump
- LX-1420** - 10 pcs. Open Stock



Air Bleeder Valve

- For use with hand operated grease guns only
 - Use to vent air pockets in hand grease guns
 - 1/8" NPT male threads
- LX-1422** - 10 pcs. Open Stock



Lubrication Accessory Kit

- 11 of Lumax's most popular lube accessories
 - Use with all standard grease guns, grease pumps and dispensing devices.
 - Organized in the convenient storage case
- LX-1470** - 1 pc. Open Stock

GREASE GUN ADAPTERS



4.5" Push-Type Adapter

- For recessed grease fittings on cars, trucks, farm equipment, etc.
- Includes slide-on locking sleeve
- A simple push-on motion quickly attaches to a standard grease coupler for fast service

LX-1409 - 10 pcs. Open Stock



Needle Nose Grease Adapter

- Dispenses a fine-line of grease through needle nose
- Can be used with grease gun extension or hose. Ideal for use on universal joints and other applications for pinpoint lubrication
- 1/8" NPT male and female ends

LX-1410 - 10 pcs. Open Stock



Narrow Needle Nose Grease Adapter 1 1/2"

- Dispenses a fine-line of grease in hard-to-reach areas
- For pinpoint lubrication
- 1/8" NPT male and female threads

LX-1411 - 10 pcs. Open Stock



Needle Nose Grease Adapter 7"

- Complete with both small and large sleeves for a quick connection to standard and heavy-duty grease couplers
- Dispenses a fine-line of grease through needle nose
- For those hard-to-reach grease spots
- 4" Needle

LX-1412 - 10 pcs. Open Stock



Narrow Needle Nose Grease Adapter 4 3/4"

- Hardened steel tip dispenses a fine-line of grease to those hard-to-reach areas
- Comes with small and large sleeves for a quick connection to grease couplers

LX-1414 - 10 pcs. Open Stock



Needle-Type Adapter 5"

- A simple push-on motion quickly attaches to a standard grease coupler for quick service
- Needle-type adapter for flush or hard-to-reach grease fittings
- Includes slide-on locking sleeve
- 3 5/8" Needle

LX-1415 - 10 pcs. Open Stock



Seal-Off Adapter

- For use with hand operated grease guns only
- Can be used with grease gun extension or hose
- Oil and grease resistant rubber tip

LX-1418 - 10 pcs. Open Stock



14" Extension Pipe Adapter

- Equipped with grease coupler and slide-on locking sleeve
- A simple push-on motion quickly attaches to a standard grease coupler for quick service
- For far-to-reach grease fittings

LX-1434 - 10 pcs. Open Stock

BRACKETS & PACKERS



Heavy-Duty, Grease Gun Bracket

- Heavy-duty permanent magnet holds grease guns firmly and securely
- Perfect for workshops, garages, manufacturing facilities, maintenance areas, even inside trucks and vans

LX-1186 - 10 pcs. Open Stock



Heavy-Duty, Shovel Bracket

- Heavy-duty spring loaded clamp
- Ideal for wall or truck mounting and in high vibration environment
- 4-Bolt design for easy & secure mounting

LX-1188 - 10 pcs. Open Stock



Grease Gun Holder

- Holds grease and suction guns securely
- Screw-mounted (LX-1168) or Magnetic (LX-1413)
- Corrosion-resistant finish

LX-1168 - 10 pcs. Open Stock

LX-1413 - 10 pcs. Open Stock



Universal Bearing Packer

- For bearing size: 1/2" ID to a maximum 4-1/2" OD
- Easily lubricates most bearings
- Threaded center post for positive locking

LX-1310 - 10 pcs. Open Stock



FITTINGS

The Lumax® Advantage

Lumax® Grease Fittings are Precision Engineered to ensure that they are Stronger and more Durable for Heavy-Duty Service and Trouble-Free Performance. Lumax® Grease Fittings are Manufactured from the Highest-Grade Materials and to Rigid Quality Standards.

All Lumax® Grease Fittings meet the Specifications as per SAE J-534 and other International Standards. Each Grease Fitting goes through several Quality Control Checks to assure the Highest Quality Level:

- Fully Hardened for extra Durability and to protect them from Wear due to Constant Use
- Ball Check in the Head Prevents Dirt and Grit from getting into the Fitting
- Heavier Wall Thickness for Extra Strength
- Zinc Plated with Yellow Passivated Finish, for Maximum Protection against Corrosion
- Stress Relieved and Tempered Carbon Steel Spring
- Every Fitting is Individually Inspected and Batch Tested to 5,000 PSI (344 Bar)
- Designed to meet the Demanding Requirements of most Truck, Automotive, Agricultural, Industrial, Marine, and Construction Equipment needs
- Apart from Standard Types, Lumax® offers an Extensive Line of Specialty Fittings in a Variety of Grades with Domestic and International Standard threads, in Custom Design Versions
- Lumax® offers all Grease Fittings in Bulk and in a Variety of Attractive Retail Packaging

Lumax® Exclusive Features

- Thread Rolled Taper Threads Are Stronger and Durable due to Hardening and Toughening of Threads. This is not achievable in Cut Thread Process, as the Threads become Brittle on the Periphery.
- Dome-Type Riveting completely covers the Spring enabling the Spring to be Firmly Secured in its Place.

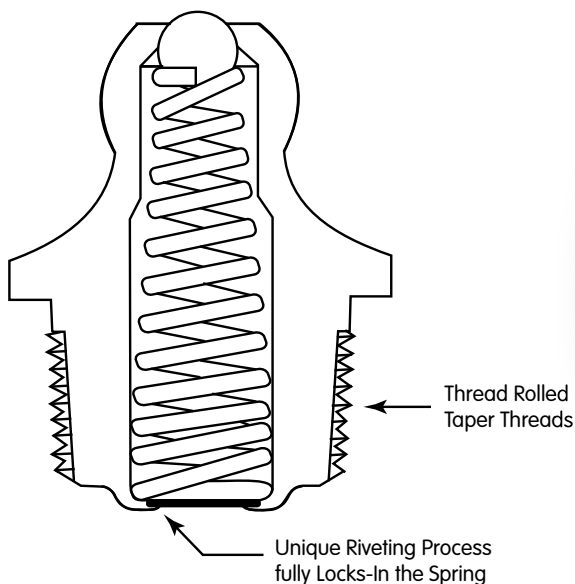

www.Lumax.com



GREASE FITTINGS

1/4"-28 Thread, Grease Fittings

Used on most Auto Vehicles and on Industrial Equipment. Conforms to Society of Automotive Engineers Lubrication Thread Specification (SAE-LT). Ball Check prevents Dust and Dirt Contamination.

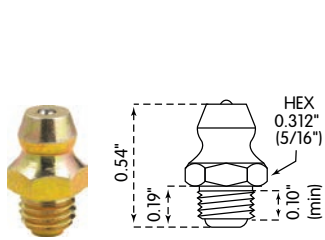

LX-3007: 1/4"-28 Taper Thread, Straight

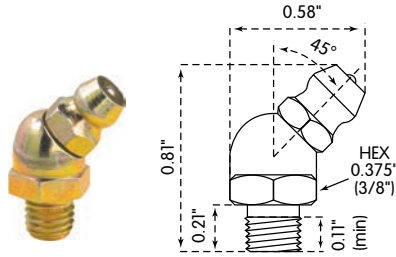

LX-3013: 1/4"-28 Taper Thread, 45°

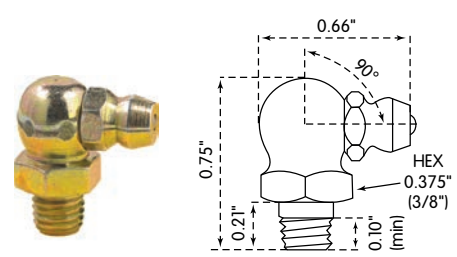

LX-3019: 1/4"-28 Taper Thread, 90°

1/8" Pipe Thread, Grease Fittings

Constructed for additional Strength, these Fittings are Ideally Suited for use on Heavy Industrial, Agricultural and Construction Equipment. Ball Check prevents Dust and Dirt Contamination.

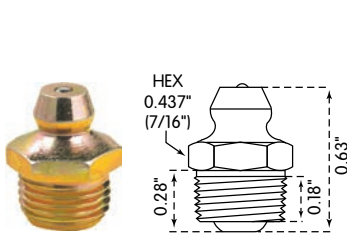

LX-3101: 1/8" PTF, Straight

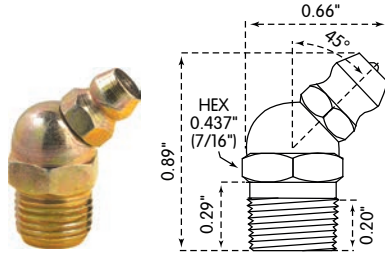

LX-3113: 1/8" PTF, 45°

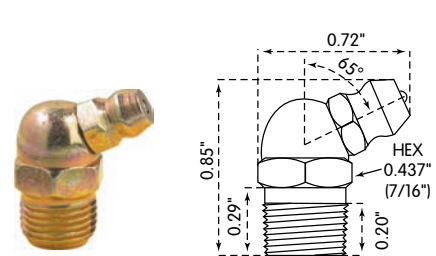

LX-3117: 1/8" PTF, 65°

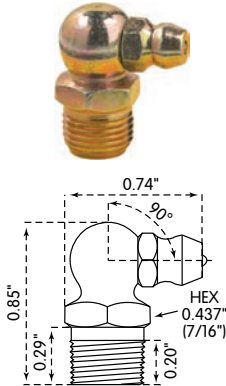

LX-3119: 1/8" PTF, 90°

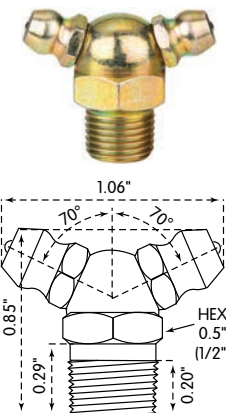

LX-3121: 1/8" PTF, 70°

Part No.	Type	Overall Length	Shank Length	Thread Length	Hex Size	Pack (Pcs.)
1/4"-28 Taper Thread (SAE-LT)						
LX-3007	Straight	0.54"	0.19"	0.10"	0.312" (5/16")	100
LX-3007-10						10
LX-3007-5						5
LX-3013	45°	0.81"	0.21"	0.11"	0.375" (3/8")	100
LX-3013-10						10
LX-3019	90°	0.75"	0.21"	0.10"	0.312" (5/16")	100
LX-3019-10						10
1/8" Pipe Thread						
LX-3101	Straight	0.63"	0.28"	0.18"	0.437" (7/16")	100
LX-3101-10						10
LX-3101-5						5
LX-3113	45°	0.89"	0.29"	0.20"	0.437" (7/16")	100
LX-3113-10						10
LX-3113-5	5					
LX-3117	65°	0.85"	0.29"	0.20"	0.437" (7/16")	100
LX-3119	90°	0.85"	0.29"	0.20"	0.437" (7/16")	100
LX-3119-10						10
LX-3119-5						5
LX-3121	70°	0.85"	0.29"	0.20"	0.5" (1/2")	100
LX-3121-10						10

Please Note: Drawings and Images are for Guidance Only and are Not to Scale. Refer to Dimensions, for Actual Size.

GREASE FITTINGS

1/4" Pipe Thread, Grease Fittings

Commonly used for Larger Bearings on Heavy Industrial and Farm Machinery and Equipment. Highly Recommended for Heavy Lubricants and in Cold Weather Applications. Ball Check prevents Dust and Dirt Contamination.

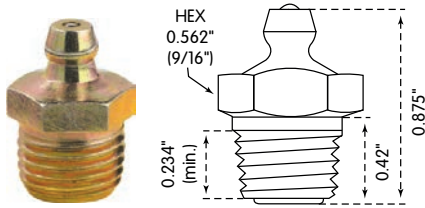

LX-3201: 1/4" PTF, Straight

Part No.	Type	Overall Length	Shank Length	Thread Length	Hex Size	Pack (Pcs.)
1/4" Pipe Thread						
LX-3201 LX-3201-10	Straight	0.875"	0.42"	0.234"	0.562" (9/16")	100 10

Drive Type, Grease Fittings

Drive Fittings avoid Tapping Costs in Variety of Applications. Circumferential Serrated Shank provides a Grease Tight Seal when Installed. They also simplify the Replacement of Damaged Fittings in Old or Oversized Holes. Recommended only for Low to Medium Pressure Applications. Drive Fittings must be used where High Lubricant Back Pressures can be Developed.

Holes Sizes and Shank Dimensions Must Be Used as Reference Only. To determine Optimum Hole Size, Test Applications should be conducted using the Type of Material into which the Fitting is to be Installed ex. Aluminum, Brass, Bronze, Cast Iron, Copper, Steel etc. Production Tolerances of Hole Size must be taken into Consideration when Test is Conducted. Use LX-1430 Drive Fitting Tool to Install these Fittings.

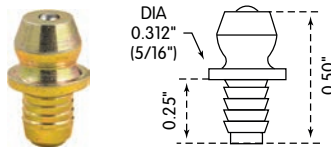

LX-3505: For 3/16" Diameter Hole, Straight

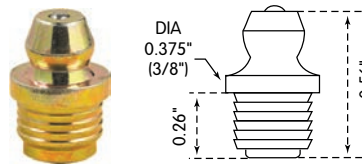

LX-3511: For 5/16" Diameter Hole, Straight

Part No.	Type	Overall Length	Shank Length	Thread Length	Diameter / Hex Size	Pack (Pcs.)
Drive Type						
LX-3505 LX-3505-10	Straight	0.50"	0.25"	0.25"	0.312" (5/16") (Hex Size)	100 10
LX-3511 LX-3511-10	Straight	0.56"	0.26"	0.26"	0.375" (3/8")	100 10

GREASE FITTINGS

Metric Thread, Grease Fittings

Used on most Imported Auto Vehicles and on Equipment. Taper Metric Thread conforms to ISO and German Standard DIN 71412. Ball Check prevents Dust and Dirt Contamination.

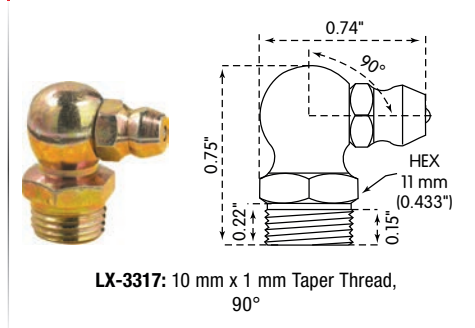
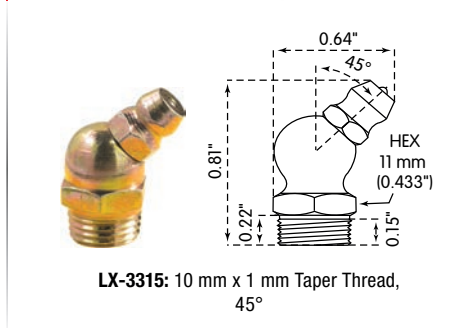
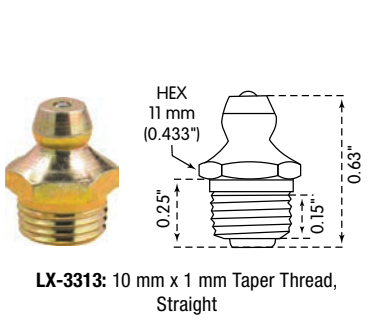
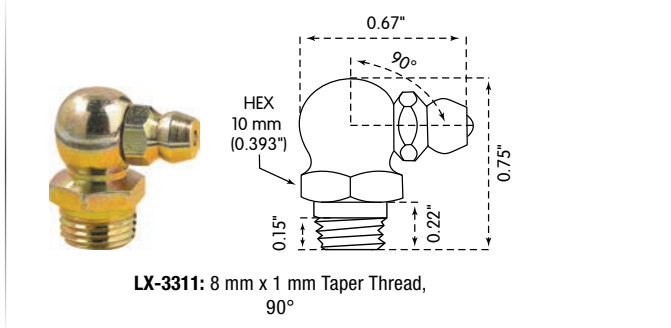
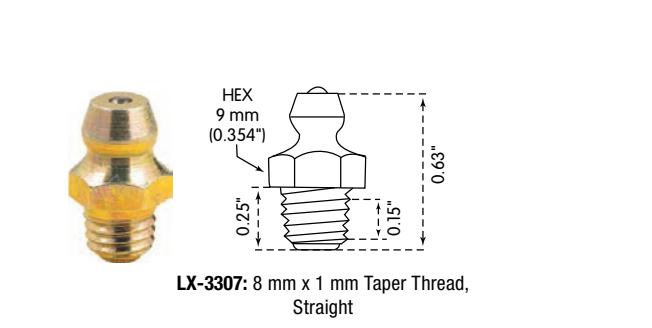
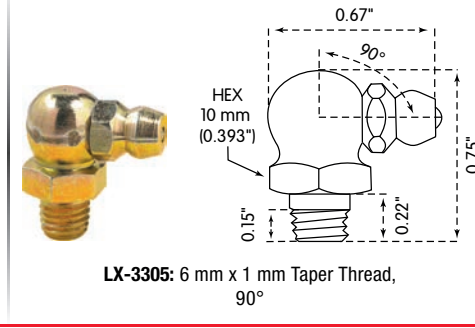
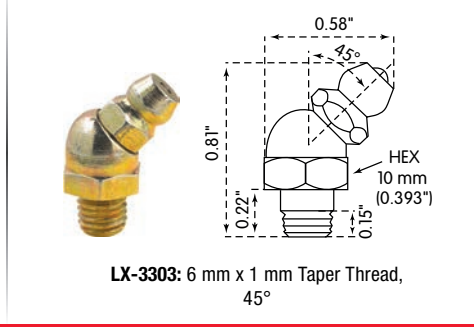
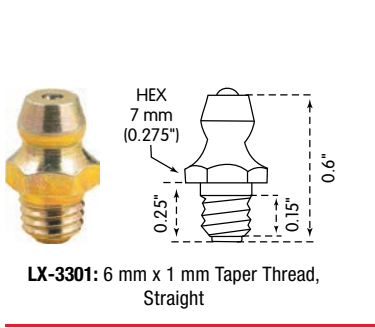

Part No.	Size	Type	Overall Length	Shank Length	Thread Length	Hex Size	Pack (Pcs.)
Metric Thread							
LX-3301 LX-3301-10 LX-3301-5	6 mm x 1 mm	Straight	0.60"	0.25"	0.15"	0.275" (7 mm)	100 10 5
LX-3303 LX-3303-10	6 mm x 1 mm	45°	0.81"	0.22"	0.15"	0.393" (10 mm)	100 10
LX-3305	6 mm x 1 mm	90°	0.75"	0.22"	0.15"	0.393" (10 mm)	100
LX-3307 LX-3307-10 LX-3307-5	8 mm x 1 mm	Straight	0.63"	0.25"	0.15"	0.354" (9 mm)	100 10 5
LX-3311 LX-3311-10	8 mm x 1 mm	90°	0.75"	0.22"	0.15"	0.393" (10 mm)	100 10
LX-3313 LX-3313-10 LX-3313-5	10 mm x 1 mm	Straight	0.63"	0.25"	0.15"	0.433" (11 mm)	100 10 5
LX-3315	10 mm x 1 mm	45°	0.81"	0.22"	0.15"	0.433" (11 mm)	100
LX-3317	10 mm x 1 mm	90°	0.75"	0.22"	0.15"	0.433" (11 mm)	100

GREASE FITTINGS

Mini-Assortments

Mini-Assortments contains Most Used Sizes and Configurations of Fittings. Eight Assorted Grease Fittings in Popular Sizes.

Metric Assortment Pack contains Three Types of Popular Metric Fittings and Covers Almost all Foreign Vehicles Applications.

Mini-Assortments are packaged on Attractive Display Card.



Set No.	Description	Contents of Assortment	Fitting No.	Qty.	Pack
LX-4801	8 pc. Assortment (SAE) 1/4"-28 Taper Thread	1/4"-28 Taper Thread, Straight 1/4"-28 Taper Thread, 45° 1/4"-28 Taper Thread, 90°	LX-3007 LX-3013 LX-3019	4 2 2	10
LX-4803	8 pc. Assortment (SAE) 1/8" PTF	1/8" PTF Short, Straight 1/8" PTF Short, 65° 1/8" PTF Short, 90°	LX-3101 LX-3117 LX-3119	4 2 2	10
LX-4805	8 pc. Assortment (SAE) 1/4"-28 & 1/8" PTF	1/4"-28 Taper Thread, Straight 1/8" PTF Short, Straight 1/8" PTF Short, 45° 1/8" PTF Short, 90°	LX-3007 LX-3101 LX-3113 LX-3119	2 2 2 2	10
LX-4807	8 pc. Assortment (Metric) 6 mm x 1	6 mm x 1 mm, Straight 6 mm x 1 mm, 45° 6 mm x 1 mm, 90°	LX-3301 LX-3303 LX-3305	4 2 2	10
LX-4808	8 pc. Assortment (Metric) 8 mm x 1	8 mm x 1 mm, Straight 8 mm x 1 mm, 45° 8 mm x 1 mm, 90°	LX-3307 LX-3309 LX-3311	4 2 2	10
LX-4809	8 pc. Assortment (Metric) 6 mm x 1 & 8 mm x 1	6 mm x 1 mm, Straight 6 mm x 1 mm, 45° 6 mm x 1 mm, 90° 8 mm x 1 mm, Straight	LX-3301 LX-3303 LX-3305 LX-3307	2 2 2 2	10

'Pocket' Assortments - Fits in Your Pocket!

Contains Two Types of the Most Popular Domestic Fittings and Three Types of Popular Metric Fittings In Attractive Handy Pack.



Set No.	Description	Contents of Assortment	Fitting No.	Qty.	Pack
LX-4825-B	30 pc. Assortment (SAE) 1/4"-28 and 1/8" PTF	1/4"-28 Taper Thread, Straight 1/4"-28 Taper Thread, 45° 1/4"-28 Taper Thread, 90° 1/8" PTF Short, Straight 1/8" PTF Short, 65° 1/8" PTF Short, 90°	LX-3007 LX-3013 LX-3019 LX-3101 LX-3117 LX-3119	10 4 2 8 4 2	1
LX-4829	30 pc. Assortment (Metric) 6 mm x 1 8 mm x 1	6 mm x 1 mm, Straight 6 mm x 1 mm, 45° 6 mm x 1 mm, 90° 8 mm x 1 mm, Straight 8 mm x 1 mm, 90°	LX-3301 LX-3303 LX-3305 LX-3307 LX-3311	8 4 3 8 3	1

Deluxe 'Shop' Assortments - Perfect for the Shop!

100 pcs. Assorted Fittings in 6 Popular Domestic (SAE) Sizes and all the Most Popular Metric Sizes. Includes "Easy-Out" 4-Way Grease Fitting Tool for installing new Straight and Angle-Type Fittings, Re-Thread Holes and removing Broken Fittings. Sturdy, Easy-to-Handle Transparent Dispenser Box with Illustrated Compartments.

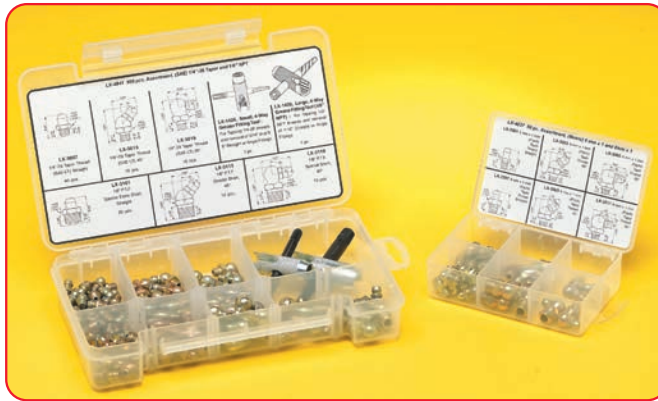

Set No.	Description	Contents of Assortment	Fitting No.	Qty.	Pack			
LX-4841	100 pc. Assortment (SAE) 1/4"-28 Taper and 1/8" PTF	1/4"-28 Taper Thread, Straight	LX-3007	40	1			
		1/4"-28 Taper Thread, 45°	LX-3013	10				
		1/4"-28 Taper Thread, 90°	LX-3019	10				
		1/8" PTF Short, Straight	LX-3101	20				
		1/8" PTF Short, 45°	LX-3113	10				
		1/8" PTF Short, 90°	LX-3119	10				
		Large, 4-Way Grease Fitting Tool	LX-1428	1				
		Small, 4-Way Grease Fitting Tool	LX-1426	1				
		LX-4843	100 pc. Assortment (Metric) 6 mm x 1 8 mm x 1 10 mm x 1	6 mm x 1 mm, Straight		LX-3301	30	1
				6 mm x 1 mm, 45°		LX-3303	15	
6 mm x 1 mm, 90°	LX-3305			15				
8 mm x 1 mm, Straight	LX-3307			10				
8 mm x 1 mm, 90°	LX-3311			5				
10 mm x 1 mm, Straight	LX-3313			10				
10 mm x 1 mm, 45°	LX-3315			5				
10 mm x 1 mm, 90°	LX-3317			5				
Large, 4-Way Grease Fitting Tool	LX-1428			1				
Small, 4-Way Grease Fitting Tool	LX-1426			1				

LX-4850 Grease Fittings Counter Display: SAE & Metric

Contains 6 Types of the Most Popular Domestic Grease Fittings and Metric Grease Fittings in Attractive Counter Display:

Assortment	Description	Qty.
LX-3007-10	1/4"-28 Taper Thread, Straight	5
LX-3101-10	1/8" PTF, Straight	5
LX-4801	8 pc. Assortment (SAE), 1/4"-28 Taper Thread	5
LX-4803	8 pc. Assortment (SAE), 1/8" PTF	5
LX-4807	8 pc. Assortment (Metric), 6 mm x 1	5
LX-4808	8 pc. Assortment (Metric), 6 mm x 1	5



800-524-1458

ACCESSORIES



Four-Way Grease Fitting Tool, Small

- All-in-One Tool to Install, Rethread and Remove Fittings
- For Tapping 1/4"-28 Threads and Removal of 5/16" and 3/8" Straight or Angle Fittings

LX-1426 - 10 pcs. Open Stock



Four-Way Grease Fitting Tool, Large

- All-in-One Tool to Install, Rethread and Remove Fittings
- For Tapping 1/8" NPT Threads and removal of 7/16" Straight or Angle Fittings

LX-1428 - 10 pcs. Open Stock



Button Head Bushing Adapter, 7/16"-27 (M) x 1/8" NPT (F)

- Adapting Standard or Large Button Head Couplers of 7/16-27 (M) threads to 1/8" NPT Connection
- Working Pressure : 3,000 PSI
- Zinc-Plated

LX-1454 - 10 pcs. Open Stock



Button Head Coupler 1/8" NPT (F), for 5/8" Button Head Fittings

- Button Head Grease Fittings
- 1/8" NPT Female Inlet
- Working Pressure: 3,000 PSI (207 Bar)
- Zinc-Plated

LX-1450 - 10 pcs. Open Stock



Button Head Coupler 1/8" NPT (F), for 7/8" Button Head Fittings

- Button Head Grease Fittings
- 1/8" NPT Female Inlet
- Working Pressure: 3,000 PSI (207 Bar)
- Zinc-Plated

LX-1452 - 10 pcs. Open Stock



Drive-in Grease Fitting Tool, Straight

- For use to Install Straight Type Drive-In Fittings
- 4-1/2" Long, 3/4" Diameter
- High-Strength Steel. Zinc-Plated

LX-1430 - 10 pcs. Open Stock



Grease Fitting Rubber Caps

- Keep Dirt, Moisture and Contamination out of Grease Fitting

LX-1458 - 10 pcs. Open Stock



Grease Joint Rejuvenator

- The Grease Joint Rejuvenator opens Clogged Grease Joints and Fittings in less than a Minute
- Works on all Automobiles, Trucks, Trailers, Aircraft, Industrial, Construction, Farming, Snow and Lawn Equipment
- Includes a 5" Flex-Hose for those Hard-to-Reach Fittings (LX-1462)

LX-1460 - Pocket Model 1 pc. Open Stock

LX-1462 - Professional Model 1 pc. Open Stock

LUMAX™

UNCOMPROMISING QUALITY



OILERS & MISC.

OILERS & MEASURERS



6 Fluid oz. Pistol Grip Oiler, 30° Rigid Spout

- 6 Fl. oz. (180mL), 30° Rigid Spout
- Zinc-Plated Rigid Spout
- Heavy-Duty, Drawn Steel Bodies
- Durable Epoxy Finish to Resist Rust

LX-1500 - 12 pcs. Open Stock



6 Fluid oz. Pistol Grip Oiler, 30° Flex Spout

- 6 Fl. oz. (180mL), 30° Flex Spout
- Zinc-Plated Rigid Spout
- Heavy-Duty, Drawn Steel Bodies
- Durable Epoxy Finish to Resist Rust

LX-1502 - 12 pcs. Open Stock



14 Fluid oz./1 Pt. Handled Oiler, 30° Flex Spout

- 14 Fl. oz./1 Pt. (480mL), Vertical Flex Spout
- Zinc-Plated Rigid Spout
- Heavy-Duty, Drawn Steel Bodies
- Durable Epoxy Finish to Resist Rust

LX-1510 - 12 pcs. Open Stock



16 Fluid oz./1 Pt. Oiler, 30° Flex Spout

- 16 Fl. oz./1 Pt. (480mL), 30° Flex Spout
- Zinc-Plated Rigid Spout
- Heavy-Duty, Drawn Steel Bodies
- Durable Epoxy Finish to Resist Rust

LX-1514 - 12 pcs. Open Stock



32 Fluid oz./1 Qt. Handled Oiler, 30° Flex Spout

- 32 Fl. oz./1 Qt. (960mL), Vertical Flex Spout
- Zinc-Plated Rigid Spout
- Heavy-Duty, Drawn Steel Bodies
- Durable Epoxy Finish to Resist Rust

LX-1518 - 6 pcs. Open Stock



Galvanized Measure with Flex Spout

- Heavy-Duty Construction
- Durable Galvanized Finish to resist Rust
- Flexible Spout with Tapered Tip for ease of Pouring
- Rolled-Edge, Easy-Grip Handles

LX-1524 - 1 Qt. 6 pcs. Open Stock

LX-1526 - 2 Qt. 6 pcs. Open Stock

LX-1528 - 4 Qt. 6 pcs. Open Stock



Flow Control Measure with Flex Spout

- Thumb Operated Valve Controls Flow - Flip-Action locks Valve Open
- 14" Flexible Spout
- Self-Locking Lid

LX-1530 - 1 Qt. 1 pc. Open Stock

LX-1532 - 2 Qt. 1 pc. Open Stock

LX-1534 - 4 Qt. 1 pc. Open Stock

LX-1536 - 5 Qt. 1 pc. Open Stock

LX-1538 - 8 Qt. 1 pc. Open Stock

FILLERS



Battery Filler, 2 Qt. Capacity

- Tough PE - polyethylene Material-Safe to Use with Battery Acid
- Shuts-Off Automatically when Battery Cell is at Proper Level- No Overfilling
- Features Double-Action Fast Flow Valve Tip that prevents After-Drip
- Stops Surface Discharge caused by a Wet Battery

LX-1618 - 6 pcs. Open Stock



Battery and Radiator Filler, 2.5 Gallon Capacity

- Tough, Polyethylene. Impervious to Oil, Gasoline, Anti-Freeze, etc.
- Durable, Oil-Resistant Plastic - will not Rust or Dent

LX-1624 - 8 pcs. Open Stock



Battery and Radiator Filler, 3 Gallon Capacity

- Tough, Polyethylene
- Durable, Oil-Resistant Plastic - will not Rust or Dent

LX-1626 - 8 pcs. Open Stock



Our comprehensive fluid transfer range has been tested for compatibility with more than 115 different chemicals. You can gain quick access to our product compatibility by scanning this QR Code!



TRANSFER

ROTARY PUMPS



Rotary Barrel Pump

- Heavy-duty cast-iron die-cast body pump for transferring non-corrosive, petroleum based fluids of light-to-medium viscosity

• Dispenses 9 fl. oz. per revolution

LX-1318 - 4 pcs. Open Stock



Premium, Dual-Direction Barrel Pump

- Excellent for transferring anti-freeze, diesel, fuel oils, petroleum based fluids of light to medium viscosity and non-corrosive, mild chemicals

• Dispenses 36 fl. oz. per Revolution

LX-1322 - 2 pcs. Open Stock



Stainless Steel Rotary Barrel Pump

- For use in dispensing fuels, harsh chemicals and liquids including various acids, alcohols, oils, solvents, ketones, DEF, water and petroleum based fluids

• Dispenses 5 GPM @70 RPM

LX-1323 - 1 pc. Open Stock



Rotary Barrel Chemical Pump

- Corrosion resistant
- Lightweight, reliable and cost-effective solution for dispensing aggressive chemicals, acidic solutions, fuels, fuel oils and DEF

• Dispenses 11 fl. oz. per revolution

LX-1321 - 2 pcs. Open Stock



Rotary Barrel Chemical Pump

- General purpose
- Cost-effective solution for dispensing mild-to-medium strength chemicals, water based fluids, DEF

• Dispenses 11 fl. oz. per revolution

LX-1324 - 4 pcs. Open Stock



Deluxe Rotary Barrel Pump

- For transferring non-corrosive mild-to-medium strength chemicals and petroleum based fluids of light to medium viscosity, such as, lubricating oils, motor oils, transmission fluid, machine oil, kerosene, gasoline or diesel fuel

• Dispenses 11 fl. oz. per revolution

LX-1320 - 4 pcs. Open Stock

LEVER ACTION PUMPS



Lever-Action Chemical Pump

- Premium
- Precision seal eliminates bypass and floating steel check valve drains liquid when not in use

• Polypropylene (PP); Acetal (POM); Viton®

LX-1329 - 6 pcs. Open Stock



Lever-Action Chemical Pump

- Corrosion resistant
- Ryton® Polyphenylene Sulfide (PPS); Teflon® (PTFE); Viton (Fluoropolymer Elastomer); Stainless Steel (SS 316)

• Two sizes of bung openings

LX-1328 - 4 pcs. Open Stock



Lever-Action Chemical Pump

- Premium
- Non-drip valve included as standard equipment and ideal for DEF use
- Fits two sizes of bung openings

LX-1327 - 4 pcs. Open Stock



Lever-Action Chemical Pump

- General purpose
- Multiple settings allows user to regulate low, normal, or high outflow
- Fits two sizes of bung openings

LX-1326 - 4 pcs. Open Stock



Heavy-Duty, Lever-Action Barrel Pump

- Fits 15-55 Gallon (57-210L) Drums with Standard 2" (50mm) and 1-1/2" (38mm) Bung Opening
- Delivers 13 oz. (390mL) per Stroke. Appx. 10 Strokes/Gallon (3.8L)

LX-1316 - 6 pcs. Open Stock

DIAPHRAGM PUMPS

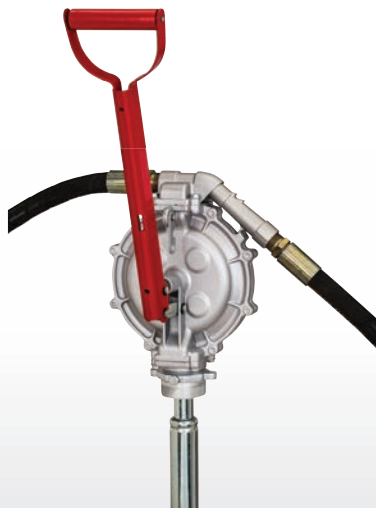

Heavy-Duty, Double-Acting Diaphragm Fuel Transfer Pump

- Fits 15-55 Gallon (57L-210L) Drums or Tanks with 2" Bung Opening
- Dispenses 1 Gallon (3.8L) in 5 Strokes
- Extra Heavy-Duty Steel Handle with Security Locking Latch

LX-1342 - 2 pcs. Open Stock



Diaphragm Chemical Pump, Corrosion Resistant

- Fits 15-55 Gallon (57L-210L) Drums or Tanks with 2" Bung Opening
- Dispenses 1 Gallon (3.8L) per 10 Strokes
- Lockable Handle

LX-1339 - 2 pcs. Open Stock

LIFT-ACTION PUMPS



Stainless Steel, Barrel Pump

- Heavy-Duty, Stainless Steel Suction Tube (# 304) and Piston, for Durability and Maximum Protection against Corrosion
- Stainless steel head with removable spout
- 55 gal drum

LX-1331 - 1 pc. Open Stock



Steel Barrel Pump

- Fits 55 Gallon Drums (210L) with Standard 2" (50 mm) Bung Opening
- Discharge Capacity: 22 Fluid Ounces (650mL) per Stroke
- 1-1/2" (38mm) Inlet Port and 3/4" (19mm) Outlet Port

LX-1330 - 6 pcs. Open Stock



Nylon Drum Pump

- Same features as LX-1332, but Made of Nylon Materials
- Stainless Steel Piston for Maximum Chemical Resistance
- 55 gal drum

LX-1334 - 2 pcs. Open Stock



Polypropylene Drum Pump

- Lightweight Portable Pump designed for 55 Gal. (210L) Drums
- Nickel-Plated Steel Piston for Maximum Protection against Corrosion

LX-1332 - 2 pcs. Open Stock

BUCKET/PAIL PUMPS



Stainless Steel Pail Pump

- 5-6.5 Gallon (20-25L) Capacity
- Flow Rate: 8 Fluid Ounces (240mL) per Stroke
- Inlet Port: 5/8"
- Outlet Port: 1/2" (12.5mm)

LX-1352 - 1 pc. Open Stock



Lever-Action Bucket Pump

- Smooth, Easy Pumping Action dispenses all Types of Lubricants, even in the coldest Weather.
- Self-Priming

LX-1300 - 5-6.5 Gallon (20-25L) Pails - 5 pcs. Open Stock

LX-1301 - 16 Gallon Drum Pump

LX-1300-RH - Replacement Hose Assembly



Grease Gun Filler Pump for 25-50 lb. (11.5-23kg.) Pails

- Filler Socket helps eliminate Waste, Mess and Air Pocket
- Delivers 1 lb. (450g) per 16 strokes

LX-1302 - 5 pcs. Open Stock



Plastic Bucket Pump with Flex Hose and Non-Drip Nozzle

- Self-Priming, Push-Down Action Pump
- 5-6.5 Gallon (20-25L) Capacity
- Discharge Capacity: 3 Fluid Ounces (90mL) per Stroke

LX-1336 - 6 pcs. Open Stock

HAND PUMPS



Brake Fluid Pump

- Fastens directly onto Can
- Comes with a 40" (1m) Hose with Check Valve for an Air-Tight Seal
- Furnished with four Cap sizes to Fit most Standard one Gallon, Plastic and Metal Containers

LX-1346 - 6 pcs. Open Stock



Multi-Purpose Oil Pump

- For precise dispensing in tough-to-reach places
- 1 Qt. (1L) Capacity Bottle
- Ounces per Stroke 0.14 oz. (4cc)

LX-1341 - 10 pcs. Open Stock



Small Engine & Marine Lower Unit Filler Pump

- For adding Fluids to Marine Lower Units
- Fits Standard Quart Bottles
- Comes with Standard 3/8"-16 Adapter

LX-1348 - 10 pcs. Open Stock



Gallon Fluid Pump

- Designed to fit Standard Gallon Containers
- Dispenses 1 Fluid Ounce (30mL) of product with each depression
- For Oil-Based Fluid Reservoirs including Differentials, Gear and Transmissions Cases

LX-1338 - 6 pcs. Open Stock



Magnetic LED Tool Light

- Magnetic LED Tool Light that attaches to tools to Light Up Dark Work Environments.
- Attaches to Most Hand Tools
- Suitable for Grease Guns, Screwdrivers, Wrenches, Pliers, Ratchets, etc.
- Strong Magnets Hold on During Operation
- Compact and Lightweight (0.25 oz. / 6.5g)
- Super Bright LED Light: 15,000MCD
- Long Life Lithium Battery. Lasts up to 7 hours of Continuous Use

LX-1436 - 10 pcs. Open Stock

LX-1436-DB - Counter Top Display - 24 pcs. LX-1436

PUMP ACCESSORIES



Electronic Flow Meter: For DEF/Urea, Chemicals, Solvents and Water

- Display can be Rotated
- Suitable for multiple forms of liquid
- *Connection Side 1" NPT
- Flow Range: 3-30 GPM (10L-100L/min)

LX-1371 - 1 pc. Open Stock



Anti-Static Rubber Fuel Hose, 13 ft. (4m) x 3/4" NPT

- High Quality Anti-Static Rubber Fuel Hose provides Rugged Protection against Abrasions, Cuts, Punctures and Snags
- Built-In Internal Spring Bend Restrictor to help prevent Kinking

LX-1374 - 1 pc. Open Stock



Diaphragm Pump Kit, AC, 110V~120V, 50/60Hz., for DEF/Urea/AdBlue

- Innovative Design provides Faster Priming, Better Performance and Longer Life
- Nylon Pump Head for Superior Durability and Resistance to Chemicals
- Features a By-Pass Valve for Motor Protection

LX-1362 - 13 ft hose - 1 pc. Open Stock

LX-1362-20 - 20 ft hose - 1 pc. Open Stock

LX-1382 - Diaphragm Pump Kit, 12VDC, for DEF/Urea/AdBlue, 13 ft. Hose

POWERED PUMPS



Diesel Fuel Transfer Pump Kit, 8GPM, 12V, DC

- Precision Cast Iron
- Flow Rate: 8GPM (30L/Minute)
- Power: 120W

LX-1375 - 1 pc. Open Stock



Heavy-Duty, Explosion Proof Fuel Transfer Pump Kit, 15GPM, 12V, DC

- Ideal for pumping Oil or Petroleum-Based Products
- Heavy-Duty, Cast-Iron Construction
- Flow Rate: 15GPM (57L/Minute)
- Work Pressure: 18 PSI (1.2 Bar)

LX-1377 - Kit, 15GPM, 12V, DC. 1 pc. Open Stock

LX-1378 - 15GPM, 12V, DC. 1 pc. Open Stock



Diaphragm Pump, 12V, DC for DEF/Urea/AdBlue

- Nylon pump head for superior durability
- Flow Rate: 11GPM (40L/min)
- Power: 300W

LX-1360 - 1 pc. Open Stock



Diaphragm Pump, 110V~120V, 50/60Hz. for DEF/Urea/AdBlue

- Features by-pass valve for motor protection
- Flow Rate: 11GPM (40L/min)
- Power: 330W

LX-1361 - 1 pc. Open Stock



Diesel Transfer Pump, 12GPM (45LPM), 12V DC

- High strength cast iron for exceptional durability
- Flow Rate: 12GPM (45L/min)
- Power: 175W

LX-1363 - 1 pc. Open Stock

PUMP NOZZLES



Stainless Steel Fuel Control Nozzle

- Automatic Shut-off Nozzle
- 3/4" NPT for DEF/Urea
- Automatic Locking Trigger for Hands-Free Operation

LX-1366 - 1 pc. Open Stock



Aluminum Fuel Control Nozzle

- Automatic shut-off nozzle
- 3/4" NPT for Oil, Diesel, Kerosene
- Spout Diameter: 15/16" (24mm)

LX-1370 - 1 pc. Open Stock



Manual Nozzle Stainless Steel, for DEF, AdBlue, Urea, 3/4" NPT

- Manual, Adjustable Trigger
- Inlet: Stainless Steel (SS 304) / Body: Polypropylene
- Inlet: 1" (25mm) / Outlet: 3/4" (19mm)

LX-1364 - 4 pcs. Open Stock



Manual Nozzle, Aluminum, for Oil, Diesel, Kerosene, 3/4" NPT

- Inlet: 3/4" NPT. Spout Diameter: 13/16" (21mm)

LX-1369 - 4 pcs. Open Stock

EXTRACTORS

Manual Fluid Extractor

- Excellent for use with Oil, Coolant and Hydraulic Systems
- Durable, Oil and Chemical-Resistant Polypropylene Construction
- Non-Spark. Non-Power Fluid Extractor
- Decompression/Exhaust Valve for Releasing Negative Pressure

LX-1311 - 1.6G (6L) Capacity 1 pc. Open Stock
LX-1312 - 2.6G (10L) Capacity 1 pc. Open Stock
LX-1313 - Manual / Pneumatic, 2-in-1 Fluid Extractor, 2.1G (8L) Capacity 1 pc. Open Stock
LX-1314 - Manual / Pneumatic, 2-in-1 Fluid Extractor, 2.6G (10L) Capacity 1 pc. Open Stock



Fluid Extractor/Dispenser

- Simple Syringe-Action to Quickly and Cleanly Extract or Dispense Fluids
- Ideal for Brake Fluid, Anti-Freeze, Power Steering Fluids, Gear Oil, Transaxles, Power Steering or Coolant.
- Lightweight and Easy-to-Clean, includes a Non-Drip Cap

LX-1386 - 7 oz. (200mL) Capacity 1 pc. Open Stock
LX-1387 - 15 oz. (450mL) Capacity 1 pc. Open Stock
LX-1388 - 34 oz. (1L) Capacity 1 pc. Open Stock
LX-1389 - 50 oz. (1.5L) Capacity 1 pc. Open Stock



DRUM ACCESSORIES



Self-Closing, Aluminum Drum Faucet, 2" NPT

- Convenience and Safety in one with the Die-Cast Aluminum Self-Closing "Push-Button" Faucet. Ideal for working with Fluids that are Chemically Compatible with Aluminum

LX-1728 - 6 pcs. Open Stock



Self-Closing, Alloy Body Drum Faucet, 3/4" NPT

- Self-Closing Safety Design
- Lever can be Locked with a Padlock
- Zinc Alloy Die-Cast Body with Zinc Plated Steel Lever

LX-1727 - 6 pcs. Open Stock



Plastic Drum Faucet, 2" NPT

- For use with 15, 30 & 55 Gallon (57L, 114L & 210L) Plastic or Steel Drums
- Large Bore for emptying Drum quickly. Empty a 55 Gallon (210L) Drum in less than 3 Minutes

LX-1726 - 6 pcs. Open Stock



Plastic Drum Faucet, 3/4" NPT

- For use with 15, 30 & 55 Gallon (57L, 114L & 210L) Plastic or Steel Drums
- Fits 3/4" Neck
- Recommended for dispensing Non-Corrosive Fluids, Lightweight Oils, Mild Chemicals, most Water-Based Fluids and Cleaning Solutions

LX-1725 - 6 pcs. Open Stock



Aluminum Drum Wrench, 3/4" Slotted and 2" Bar Bung

- Non-Sparking Cast Aluminum
- Hardened and Tempered for Increased Strength
- Offset Handle for increased Leverage

LX-1724 - 6 pcs. Open Stock



FUNNELS & DRAINS



Galvanized Steel Funnel with 12" Flex Spout

- Heavy-Duty Galvanized Steel Construction
- Fine-Mesh Stainless Steel Strainer
- Ideal for adding Transmission Fluid
- 12" (30cm) Flex Metal Spout with Taper Tip for Hard-to-Reach Spots

LX-1704 - 12 pcs. Open Stock

FUNNELS



Steel Transmission Funnel, 2 Qt. with 18" x 1/2" Flex Pipe

- Offset Design - High, Splash-Proof Rim
- Durable Epoxy Finish to Resist Rust
- Fine-Mesh Stainless Steel Strainer
- 18" (45cm) Flexible Spout with Tapered Tip for Ease of Pouring

LX-1705 - 6 pcs. Open Stock



Galvanized Steel Offset Funnel, 6 Qt.

- Bright-Zinc Galvanized Corrosion-Resistant Finish
- Heavy-Duty Construction for Rugged Use
- Grooved Spouts for Air-Venting
- Fine-Mesh Stainless Steel Strainer

LX-1706 - 6 pcs. Open Stock



Galvanized Steel Funnel, 8 Qt.

- Bright-Zinc Galvanized Corrosion-Resistant Finish
- Heavy-Duty Construction for Rugged Use
- Grooved Spouts for Air-Venting
- Fine-Mesh Stainless Steel Strainer

LX-1708 - 6 pcs. Open Stock



Galvanized Steel Tractor Funnel with Locking Tabs, 8 Quart

- Same as LX-1708, but has Stabilizing Locking Tabs on the Spout

LX-1708T - 6 pcs. Open Stock



Galvanized Steel Funnel

- Heavy-Duty Construction for Rugged Use
- Grooved Spouts for Air-Venting

LX-1700 - 1 QT 12pcs. Open Stock

LX-1702 - 2 QT 12pcs. Open Stock

EXTRAS



Tire and Tube Test Tank

- Made from Rugged Heavy-Duty Polyethylene
- Features Reinforced Ribs for Extra Support
- Dimensions: 31" x 12" x 12" (790mm x 300mm x 300mm)

LX-1640 - 1 pc. Open Stock

DRAINS



Galvanized Drain Pan, 3.5 Gallon Capacity

- Zinc Galvanized, Corrosion-Resistant finish
- Rolled Rim and Ribbed bottom for Extra Strength
- 16" (400mm) Diameter
- 4" (100mm) Deep

LX-1709 - 12 pcs. Open Stock



Galvanized Drain Pan, 6 Gallon Capacity

- Zinc Galvanized, Corrosion-Resistant finish
- Ribbed Bottom for Extra Strength
- 19" (480mm) Diameter
- 6" (150mm) Deep

LX-1710 - 4 pcs. Open Stock



Metal Oil Lift Drain

LX-1712 - 5 Gallon Capacity - 1 pc. Open Stock

LX-1713 - 5 Gallon Capacity with Cross Frame Dolly - 1 pc. Open Stock

LX-1716 - Cross Frame Dolly for LX-1712 Metal Waste Oil Drain - 1 pc. Open Stock

LX-1722 - 24" Band Dolly for 55 Gallon Containers - 1 pc. Open Stock

LX-1638 - Transmission Pan Adapter for Oil Lift Drain, 24" Diameter - 4 pcs. Open Stock



PROVIDING SAFER DRIVING SOLUTIONS



HELPING CUSTOMERS PREVENT ACCIDENTS

SAFETY ACCESSORIES

SAFETY TOP OF MIND

Creative innovation that has your safety top of mind. Accidents are just what they are, accidents, but we can help eliminate some of those with our products

DRIVING AWARENESS SOLUTIONS™

Making drivers safer with easy-to-install innovative solutions to common driving hazards

ALWAYS THERE

Smart and innovative products that are easy to use and there when you need it!





The Only High Definition
Wireless Trailer Camera
That Installs In Minutes!

A SMART WAY TO SEE BEHIND YOUR TRAILER

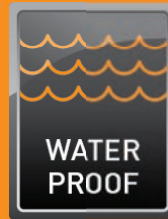
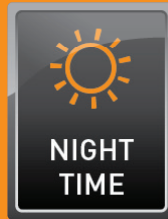

vueSMART™ Wireless Trailer Camera™

- Easy do-it-yourself installation uses existing trailer light for power and adapts to work on any trailer with universal bracket
- Wifi connection sends crystal clear video to smart device
- Hi-definition camera delivers 152° wide angle view behind trailer
- LED lights for night time backing
- Take a picture or record video
- Waterproof

50050 - 1 pc. Open Stock



SMART HITCH™ CAMERA

Hitching up is a one person job!



SCAN HERE
TO SEE IT
IN ACTION

50002
SMART HITCH™

Camera and Sensor System - 2 pcs. Open Stock

TWO MODES ARE BETTER THAN ONE

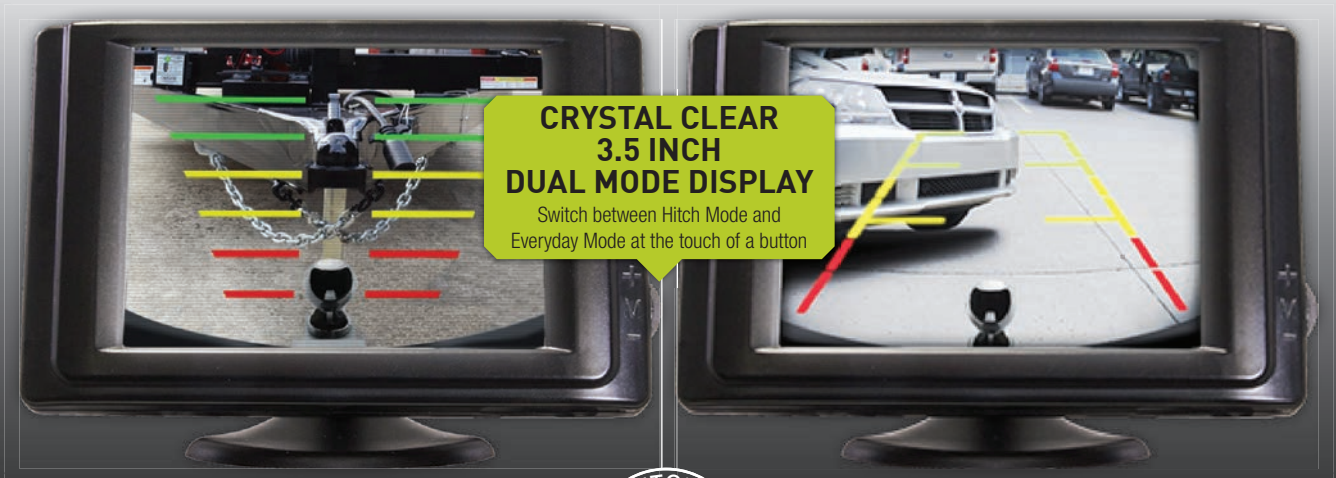

**CRYSTAL CLEAR
3.5 INCH
DUAL MODE DISPLAY**

Switch between Hitch Mode and
Everyday Mode at the touch of a button

HITCH MODE

- Turns hitching into a one person job
- Helps align ball to trailer every time
- Provides a channel for perfect alignment
- Distance guides help determine how close objects are
- Audible alerts for proximity



EVERYDAY MODE

- Works for everyday use when not towing
- Detects objects 5.5 feet away
- Sends audible alert for when you're not looking
- Utilizes ultra-sonic sensing

VEHICLE CAMERA





Rearview Camera/Sensor System

- Helps reduce blind spots and increase visibility
- Camera with sensor combination
- Works in all weather conditions, including at night
- Installs in 3 easy steps
- Easily mounts behind license plate

60195VA - 2 pcs. Open Stock



Back Up Sensor System

- Perfect for cars, trucks and SUV's
- Detects objects up to 5.5 feet away
- Easily mounts behind license plate

60100VA - 2 pcs. Open Stock



50 Watt Halogen Super-Bright Back-Up Alert™

- Warns pedestrians as you back up
- Replaces existing back-up bulb
- As easy as screwing in a light bulb
- Audible "beep-beep" sound when vehicle is in reverse
- Lifetime warranty

28701VA - 3156 bulb 10 pcs. Blister



50 Watt Halogen Super-Bright Back-Up Alert™

- Warns pedestrians as you back up
- Replace existing back-up bulb
- Audible "beep-beep" sound when vehicle is in reverse
- Lifetime warranty

20101VA - 10 pcs. Bulk/Box

GREAT PROMOTIONAL OPPORTUNITY



TRAILBLAZER ELECTRONIC



DEER ALERT™

Improving Driver Safety —with Animal Alerts



Deer accidents cause over \$1 Billion in damage every year. This premium Deer Alert is the perfect step-up

3 PROMO OPTIONS IN 1 SKU!

This product ships ready for display! Use the provided attractive tray or hang packages on the included clip strip



Trailblazer Electronic Deer Alert™

- Powerful electronic signal
- More effective than traditional deer whistles
- 1,100 feet of reaction time warning
- Easy installation ... Hidden from view
- Won't clog ... Keeps working

27512VA – 8 pcs. Open Stock, Tray Pack, Clip Strip



Deer Warnings Chrome

- Produces dual-pitched sounds to alert nearby animals
- Air flow activation
- Adhesive mount included for easy installation

22-1-01001-8 - 3 pcs. Open Stock



Deer Warnings Black

- Produces dual-pitched sounds to alert nearby animals
- Air flow activation
- Adhesive mount included for easy installation

22-1-01000-8 - 3 pcs. Open Stock

CUSTOMIZABLE KITS FOR ALL PROJECTS



MAKE IT ANY SIZE™

DIY ORGANIZATION

ANY SIZE, ANY SPACE, ANYWHERE!

2x4 Basics® offers the most versatility and customization in garage organization as well as outdoor furniture kits.

The flexibility of the product allows all customers the opportunity to get the most out of any space. 2x4 Basics® offers quick solutions that can be built ANY SIZE and fit ANY SPACE!

DIY SIMPLIFIED

Only 90 degree cuts are required making 2x4 Basics® projects quick and easy even for novice DIY'ers. To simplify the process even more, only 2x4 lumber is needed for most projects

HIGH QUALITY

Made of heavy gauge structural resin, all 2x4 Basics® brackets have a simple yet durable design allowing them to hold up to rough conditions. All 2x4 Basics® items come with 2-Year warranty

2x4 basics®



GARAGE ORGANIZATION SOLUTIONS IN ANY SIZE



Made in USA



L-Shaped Work Bench™

BLACK

- Heavy-duty L-shaped work bench fits in any corner workspace
 - Kit includes 5 work bench legs and hardware
- 90165ONLMI - 1 pc. Open Stock



L-Shaped Work Bench Kit with Shelf Links®

BLACK

- Heavy-duty L-Shaped work bench and Shelf Links create the ultimate corner workspace
 - Kit includes five work bench legs, six 16" Shelf Links and hardware
- 90162ONLMI - 1 pc. Open Stock

*Peg board not included



Work Bench Kit

BLACK

- Build a heavy-duty work bench up to four feet wide and eight feet long
 - Middle shelf can be left out to store larger items
- 90158MI - 1 set Open Stock



Work Bench Kit with Shelf Links®

BLACK

- Heavy-duty work bench and Shelf Links create the ultimate workspace
 - Kit includes four work bench legs, six 16" Shelf Links and hardware
- 90164MI - 1 set Catalog / Online

*Peg board not included

DIY ORGANIZATION KITS





BLACK

Shelf Links® - 6 pack

- 16" deep shelves made of heavy gauge structural resin
- Can be modified or expanded as storage requirements change

90128MI - 6 pcs. Open Stock
 90120MI - 30 pcs. Open Stock
 90124MI - 1 pc. Catalog / Online



BLACK

Pro Brackets™ Sawhorse - 2 pack

- Great for professionals or do-it-yourselfers
- Customize to fit your need - three, four or five feet

90194MI - 4 sets Open Stock
 90196MI - 1 set Catalog / Online



*2 kits shown



BLACK

Firewood Rack - 2 pack

- Any size up to eight feet
- Use two kits and create a multi-layer or multi-section structure

90142MI - 12 pcs. Open Stock
 90144MI - 1 set Catalog / Online



BLACK

Log Stacker™ - 2 pack

- Any size up to eight feet
- Quick and easy assembly, no hardware needed
- Stacks up to one face cord of wood

PB40000 - 8 pcs. Open Stock
 PB400000NL - 1 set Catalog/Online



BLACK

StudTrack™

- Organize long-handled tools, electric cords or sporting equipment
- Includes two end brackets and six universal hooks

90101MI - 4 sets Open Stock
 901011MI - 1 set Catalog / Online



Made in USA

DIY INSPIRATION

Customized Outdoor Space



Barn Roof Shed Kit

METAL

- No angled cuts — saves time and money!
- One kit builds a shed up to 10 feet, combine kits for a shed up to 22 feet
- Kit includes 55 metal brackets, hardware and plans

90190MI - 3 kits Open Stock
901901MI - 1 kit Catalog / Online



Peak Roof Shed Kit

METAL

- No angled cuts — saves time and money!
- One kit builds a shed up to 10 feet, combine kits for a shed up to 22 feet
- Kit includes 39 metal brackets, hardware and plans

90192MI - 4 kits Open Stock
901921MI - 1 kit Catalog / Online



CHAIRS/BENCHES



Flip-Top Bench Table™

SAND

- Converts from bench to table using patented slide-lock feature
- Convert two benches to make table that seats eight

90110MI - 1 set Open Stock
90110NLMI - 1 set Catalog/Online



AnySize Chair®

SAND

- Build a two foot chair up to an eight foot bench
- Includes integrated beverage holders

90134MI - 1 set Open Stock
901340NLMI - 1 set Catalog/Online



TABLES



Picnic Table Kit

- Makes a set of table and chairs up to eight feet
- Comes with Patio Table brackets and two AnySize™ Table sets

90182MI - 1 set Open Stock
90182ONLMI - 1 set Catalog/Online

SAND



Patio Table

- Make a table of any length up to eight feet
- Made of durable and maintenance-free structural resin

90152MI - 1 set Open Stock

SAND



AnySize Table™

- Determine the size to suit your needs
- Versatile application makes coffee table, foot rest, bench and more up to eight feet

90140MI - 1 set Open Stock
90140ONLMI - 1 set Catalog/Online

SAND



www.2x4Basics.com

DEKMATES™



Dekmate® Bench Bracket

- Can be used with new and existing decks
- Space-saving packaging design

90166MI - 12 pcs. Open Stock
90168MI - 2 pc. set Catalog Online

SAND



Dekmate® Bench Bracket

- Can be used with new and existing decks
- Space-saving packaging design

90170MI - 12 pcs. Open Stock
90172MI - 2 pc. set Catalog Online

BLACK



Dekmate® Bench Bracket

- Can be used with new and existing decks
- Space-saving packaging design

90174MI - 12 pcs. Open Stock
90176MI - 2 pc. set Catalog Online

REDWOOD



NORTH AMERICA'S

As the recognized automotive industry leader in

TOWING ELECTRICAL AND LIGHTING PRODUCTS,

the Hopkins Towing Solutions® brand is synonymous with trust, while delivering superior value to both the consumer and you, our valued customers.



#1 TOWING BRAND

SCAN HERE

To Download the
2024 Hopkins
Towing Guide

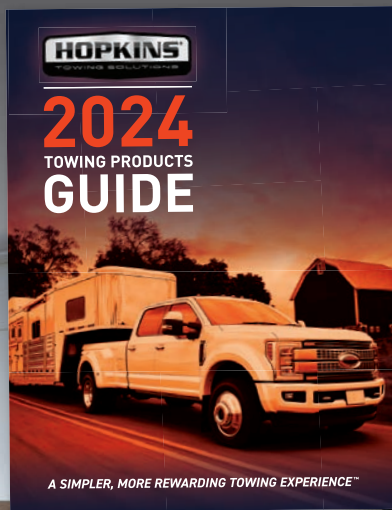

CAMERA

MARKER/
CLEARANCE
LIGHT

STOP/TAIL/
TURN LIGHT

REFLECTOR

LICENSE PLATE
LIGHT

RV TOW BRAKING

CALL

(800) 524-1458

ONLINE

www.HopkinsTowingSolutions.com

EMAIL

sales@HopkinsMfg.com

INDEX

Part	Page	Part	Page	Part	Page	Part	Page
0		9-288	50	22-1-70340-8	85	22-5-00895-8	72
05007MI	172	9-368	46	22-1-70359-9	83	22-5-00896-8	72
05015MI	172			22-1-70387-9	83	22-5-00897-8	70
05034MI	172, 181	10		22-1-70395-9	83	22-5-00900-8	72
05060MI	172	10NY-24A	59	22-1-70411-8	84	22-5-08770-8	70
05062MI	170			22-1-70412-8	84	22-5-08826-8	76
05064MI	172	12		22-1-70418-9	83	22-5-16010-8	67
05068MI	172	12-8NY-48	59	22-1-70452-9	82	22-5-16020-8	67
05080MI	169	12-808NYU	60	22-1-72020-8	87	22-5-16030-8	67
06064MI	171	12-810NYU	60	22-1-72021-8	87	22-5-16040-8	67
				22-1-72022-8	87	22-5-16045-8	67
2		22		22-1-72023-8	87	22-5-16055-8	66
2-38	51	22-1-00051-8	103	22-1-73000-9	6, 86	22-5-16070-8	67
2-48	51	22-1-00337-8A	102	22-1-96126-9	96	22-5-16110-8	68
2-108	51	22-1-01000-8	103, 215	22-1-97006-9	96	22-5-16120-8	68
2-303M8	45	22-1-01001-8	103, 215	22-1-97023-9	97	22-5-16130-8	68
2-668	51	22-1-22235-8	104	22-1-97029-9	97	22-5-16140-8	68
2-2548	51	22-1-29015-8	104	22-1-97032-9	97	22-5-57107-8	65
2-3548	51	22-1-30230-8	104	22-1-97037-9	96	22-5-57109-8	65
		22-1-33225-8	102	22-1-97049-9	96	22-5-57120-8	65
3		22-1-33653-8	100, 101	22-1-97152-9	97	22-5-60012-8	70
3-591-158	51	22-1-33671-8	102	22-1-97313-9	97	22-5-60084-8	72
3-685-58	51	22-1-36707-8	103	22-1-97315-9	96	22-5-60087-8	72
3-5018	49	22-1-37015-8	104	22-1-97443-9	84, 95	22-5-60090-8	71
3-5028	49	22-1-39011-8	105	22-1-97478-924	95	22-5-60096-8	71
3-5068	49	22-1-39047-8	105	22-1-97487-924	95	22-5-60104-8	70
3-5078	49	22-1-39052-8	105	22-1-97505-9	84, 95	22-5-60105-8	71
3-5088	49	22-1-39264-8	104	22-1-97517-9	97	22-5-60116-8M	72
3-5108	50	22-1-39268-8	104	22-1-97596-9	95	22-5-60181-8	79
3-5118	48	22-1-46009-8	98	22-1-97651-9	97	22-5-60190-8	71
3-5128	50	22-1-46104-8	99	22-1-97652-9	96	22-5-60195-8	71
3-5158	49	22-1-46117-8	98	22-1-97653-924	93, 96	22-5-70003-8	70
3-5238	51	22-1-46144-8	98	22-1-97654-9	95	22-5-70008-8	67
3-5278	51	22-1-46215-8	99	22-1-97655-9	97	22-5-70023-8	70
3-5288	51	22-1-46497-8	98	22-1-97656-9	97	22-5-70083-8	67
3-5288-7	51	22-1-46501-8	99	22-1-97657-9	95	22-5-70105-8	76
3-5308	51	22-1-46565-8	98	22-1-97658-9	95	22-5-70106-8	75
3-5368	51	22-1-46714-8	98	22-1-97659-9	95	22-5-70108-8	70
3-5368-5	51	22-1-46724-8	99	22-1-97660-9	95	22-5-70110-8	74
3-5378	51	22-1-46725-8	93, 99	22-1-97661-924	96	22-5-70111-8	76
3-5418	48	22-1-46733-8	87	22-5-00088-8	67	22-5-70112-8	76
3-5428	51	22-1-46734-8	6, 87	22-5-00101-8	75	22-5-70126-8	74
3-5588	51	22-1-55302-A	92	22-5-00102-8	75	22-5-70128-8	74
3-6068	48	22-1-55303-A	92	22-5-00103-8	75	22-5-70132-8	74
3-6828	51	22-1-55508-9	91	22-5-00104-8	75	22-5-70141-8	79
3-6848	51	22-1-56258-9	90	22-5-00108-8	75	22-5-70173-8	77
3-6848-7	51	22-1-56259-8	90	22-5-00370-VCT12	104	22-5-70174-8	79
		22-1-58048-9	91	22-5-00370-VP6	104	22-5-70184-8	75
4		22-1-58051-9	91	22-5-00401-8	76	22-5-70200-8	78
4-10NY-E	58, 59	22-1-58228-9	91	22-5-00402-8	76	22-5-70204-8	73
4-5038	58	22-1-70007-9	89	22-5-00406-8A	75	22-5-70207-8	73
4B3208	44	22-1-70008-9	89	22-5-00419-8A	74	22-5-70260-8	78
4B3278	44	22-1-70009-9	89	22-5-00420-8	76	22-5-70265-8	77
		22-1-70013-8	89	22-5-00500-SZ	157	22-5-70266-8	77
8		22-1-70019-8	6, 87	22-5-00500-SZCS12	157	22-5-70267-8	77
8NY-16A	59	22-1-70022-8	6, 87	22-5-00500-SZFB24	157	22-5-70341-8	78
8NY-24A	59	22-1-70025-8	6, 87	22-5-00710-8	79	22-5-70405-8	76
8NYE-48	58	22-1-70033-8	6, 87	22-5-00711-V	79	22-5-70407-8	75
		22-1-70231-9	83	22-5-00713-8	79	22-5-70410-8	78
9		22-1-70239-9	83	22-5-00714-8	79	22-5-70413-8	79
9-21M8	46	22-1-70274-9	93	22-5-00715-8	77	22-5-70414-8	76
9-21M8-7	46	22-1-70296-9	93	22-5-00716-8	77	22-5-70415-8	79
9-27MC8	51	22-1-70329-8	85	22-5-00726-8	78	22-5-70418-8	78
9-28MC8	50	22-1-70331-9	83	22-5-00876-8	72	22-5-70525-8	70
9-38	47	22-1-70332-9	83	22-5-00887-8	72	22-5-70600-8	76
9-38-7	47	22-1-70336-8	92	22-5-00889-8	71	22-5-70707-8	78
9-198	50	22-1-70337-3	92	22-5-00890-8	70	22-5-70709-8	78
9-278	50	22-1-70337-8	92	22-5-00894-8	72	22-5-70712-8	79

Part	Page	Part	Page	Part	Page	Part	Page
22-5-70718-8	79	841R-36	179	7000		10634GT	164
22-5-70721-8	77	843-24	178	7500MA	67	10701	172, 181
22-5-70722-8	77	843-24-116	178			10701MX2	172, 181
22-5-70731-8	78	843-30	178	9000		10701MXPW	172, 181
22-5-70746-8	78	843-30-116	178	9000R	60	10701WR	172, 180
22-5-70747-8	78	843-36	178	9003R	60	10703	171, 181
22-5-70851-8	77	844-24	178	9005R	60	10703WR	171, 180
22-5-70874-8	70	844-30	178	9007R	60	10704	171, 181
22-5-70881-8	70	844-30-116	178	9008BLK	60	10705	170, 181
22-5-70902-8	72	844-36	178	9010R	59	10709	171, 181
22-5-70925-8	69	845-24	178	9014R	59	10709WR	171, 180
22-5-70926-8	69	845-24-46	178	9020A	58	10710WR	172, 180, 181
22-5-70927-8	69	846-30	178	9025CDF	45, 61	10711	171, 181
22-5-71106-8	71	846-30-54	178	9031R	59	10712MXPW	172, 181
22-5-71110-8	71	885	58	9032R	59	10712PDQ	181, 182
22-5-71939-8	79	886PKCFB	158	9033R	60	10712WR	172, 180
22-5-84042-8	71			9037R	59	10713	172, 181
22-5-84043-8	71	900		9038	45	10714MX3	171, 181
		989-34	153	9039R	59	10716PDQ	171, 181
24		994PKUS	158	9045RA	58	10716WR	171, 180
24-808NY-30A	59	996-35FB	152, 153	9046	59	10718	170, 181
		999CT	153	9047R	59	10718WR	170, 180
50				9049	58	10719	171, 180
50-203	154	1000		9050	60	10719PDQ5	171, 181
		1124F	155	9051	60	10732PDQ	171, 181
100		2000		9053	59	10732WR	171, 180
110U	60	2000LV	167	9057	59	10800/6	173
111U	60	2005LV	167	9058	59	10800X/6	173, 180
112U	60	2248FD	154, 159	9217Blk	60	10801	173
116	179	2248FD	154, 159	9221Blk	60	10802	173
118-54	60	2610FD	150, 159	9260	60	10803	173
130-46	179	2610XB	150	9262B	59	10803PDQ	173
148	60	2610XM	150	9263	59	10804	173
154	179			9266	59	10804/4	173
160	60	3000		9267A	59	10810	173
		3101	109	9271X	56		
200		3102	109	9272X	56	11000	
203	154	3104	109	9274X	56	11430MI	169
		3304	113	9275X	56, 61	11849MI	169
300		3305	113	9425CDX	56, 61	11909MI	163
3720DM	143	3512PBT	151	9438X	56, 61	11912MI	163
376BDM	143	3518FD	153, 159	9500	58	11930MI	163
376RDM	143	3648	159	9501	60	11933MI	163
3810DM	143			9507	60	11935MI	163, 181
		4000		9508	60		
500		4320	113	9514	60	12000	
511-E	151	4322	112			12080	8, 147, 152
518RFB	154	4326	112	10000		12201	156
523FB	152, 154	4754	112	10101B/12	172	12324	157
532	154	4766	112	10101WB	172, 180	12501	157
580-EP	151			10106B/6	172, 181	12505	157
581-EFB	8, 150, 152	5000		10106WB	172, 180	12550	156
583-EPRFB	8, 150, 152	5060TS	167	10107B/12	172		
		5441B	134	10107WB	172, 180	13000	
800		5442B	134	10111/6	172	13014	155
806NY	58	5526	113	10111X/6	172, 180	13020	149, 153
817S2	159	5641B	134	10119B/24	172, 181	13024	153
840-24	178	5642B	134	10202	177	13025	153
840-24-116	178			10202PDQ12	181	13030	149, 153
840-30	178	6000		10617GT	165	13044	155
840-36	178	6018	44	10619	165	13050	149, 155
840R-24	179	6400KT	111	10620GT	164	13054	151
840R-36	179	6403	111	10621GT	164	13059	151
841-24	178	6404	111	10622GT	164	13060	149, 151
841-24-116	178	6416	111	10627GT	165	13781	153
841-30	178	6417	111	10631GT	164	13920	155
841-36	178	6418	111	10632GT	165	13920CS	155
841R-24	179			10633GT	165	13929	155

INDEX

Part	Page	Part	Page	Part	Page	Part	Page
14000		40000		45000		90043	38
14012	155	40046	51	45054	51	90049	39
14014	153	40046D	51, 61	45063	50	90051	39
14015	150	40047	51	45066	48	90060	38
14035	148	40048	51	45067	48	90063	39
14038	148	40050	51	45069	49	90064AS	33
14039	148	40050D	51, 61	45070	48	90065AS	33
14052	147	40051	51	45078X	57, 61	90068AS	36
14120	155	40059AS	37	45068	48	90072	39, 61
14120Y	155	40061	48	45114	46	90101MI	219
14125	146, 155	40061D	48, 61	45116X	57, 61	90110MI	220
14126	155	40062	48	45122X	57, 61	90120MI	219
14135	146, 151	40062D	48, 61	45128AS	37	90124MI	219
14151	146, 148	40065	51	45133	36	90128MI	219
14161	146, 147	40065D	51, 61	45135	36	90134MI	220
14165	146, 147	40067	51	45211	49	90140MI	221
14170	148	40069	51	45218	55	90142MI	219
14180	148	40071	51	45222X	57	90144MI	219
14185	146, 148	40072	51	45223X	57	90152MI	221
14403	150	40106	47	45225X	57	90158MI	218
14415	9, 151	40110	46	45320	45	90162ONLMI	218
14454	149, 150	40112	46	45401AS	31	90164MI	218
14462	147, 149	40118	50	45544X	57, 61	90165ONLMI	218
		40119	50	45602AS	36	90166MI	221
15000		40122	50	45604AS	36	90168MI	221
15613	154	40123	50	45606AS	37	90170MI	221
15781	147	40208	49	45619X	57	90172MI	221
		40209	49	45625AS	37, 61	90174MI	221
16000		40210	49	45646AS	37	90176MI	221
16024	154	40211	49	45651AS	31	90182MI	221
16211	155	40302	46	45652AS	31	90190MI	220
16250	155	40304	46	45704	54	90192MI	220
16511	154	40305A	36			90194MI	219
16620	153	40306	46	50000		90196MI	219
16621	155	40307	45	50002	213		
16721	155	40309	45	50050	212	92000	
		40310	45	50863MI	169	92004	35
		40313	47			92010	34
17000		40314	47	57000		92011	34
17211	157	40400AS	31	571000C	25	92012	34
17222	157	40401AS	31	571640C	25	92014	34
17222HT	157	40402AS	31	572000C	24	92016	43
17228	157, 159	40403AS	31	572010C	25	92017	42
17230	9, 157	40404AS	31	572040C	26	92018	34
17297	157, 159	40405AS	31	572050C	26	92019	43
17505	156	40406AS	31	572080C	25	92019WR	43
17511	156	40407AS	31	572130C	25	92022S	40
17529	156	40408AS	31	572140C	26	92025	34
17540	156	40409AS	31	572150C	5, 26	92034	34
17541	156, 159	40411AS	31	572170C	26	92036	34
17545	156			572200C	5, 24	92038AS	5, 35
		42000				92043	43
18000		42001MI	168	60000		92043WR	43, 61
18520	154	42003MI	168	60100VA	214	92046	44
18833	147	420032MI	168	60195VA	214	92046WR	44, 61
18837	159	42004MI	168			92047	43
18841	147	42008MI	168	63000		92047WR	43, 61
18847	147, 159	42010MI	169	63148	59	92048AS	5, 35
18849	151	42108MI	169			92049	35
		42113MI	7, 169	80000		92143	43
				80037	147	92215	33
19000		44000		80038	147	92216	33
19230	159	440040C	24	80052	150	92230	33
19520	154	440050C	24			92508	60
		441250C	28	90000		92509	60
20000		441280C	28	90005	39	92510	60
20101VA	214	441350C	28	90016	39	92511	60
27512VA	215	441400C	28	90042	38		
28701VA	214						

Part	Page	Part	Page	Part	Page	Part	Page
93000		97372AS	35	AX4050K	136	CWL523	119, 141
93006	55	97373AS	34	C		CWL524D	121
93007	55	420000		C36CAC	132	CWL524S	121
93008PC	55	420013MI	168	C37CAC	132	CWL525	119, 141
93012	42	4210836MI	169	C38CAW	132	CWL526	118, 141
93019	44	900000		C41CAC	133	CWL527	119, 141
93025	42	901011MI	219	C41CACH	133	CWL528	118, 141
93027	43	901100NLM	220	C42A	134	CWL529	118, 141
93028	44	901340NLM	220	C43A	133	CWL536D	121
93036	42	901901MI	220	C48AW	133	CWL536S	121
93039	42	901921MI	220	C48AWH	133	CWL552D	121
93043	44	100000000		C52CW	123	CWL552S	121
93044	44	1090130056	159	C123	140	CWL610	128
93047	43	1090800052	159	C125	140	CWL615	128
93052	40	A		C3022K	120	CWL620	128
93053	41	AH7000C	16	C3062K	136	CWL622	126
93053D	41, 61	AH7000G	16	C3067K	136	CWL623	126
93055	40	AH7000T	16	C3072K	124	CWL624	128
93058	41	AH7000V	16	C3073K	125	CWL625	128
93058D	41, 61	AH7100NEC	17	C3073KFM	124	CWL626	128
93060	41	AH8001ST	20	C3075K	125	CWL627	128
93060D	41, 61	AH8001SU	20	C4500AW	132	CWL630	129
93062	40	AH8001TK	20	C4842	133	CWL631	129
93062D	40, 61	AH8200CB	19	C4843	134	CWL636	129
93063	40	AH8200NEC	19	C4850AW	132	CWL637	129
93069	60	AH8200PAWSMY	20	C4850CAC	131	CWL638	129
93072	32	AH8200PAWSRB	20	C4850CACH	131	CWL639	129
93089A	41	AH8200SPT	19	C4855AW	131	CWL692	129
93089D	41, 61	AH8202CB	19	C4855CAC	132	CWL1116	123
93097A	32	AH8202NEC	19	C4855CAW	131	CWL5042	138
93097D	32, 61	AH8220MID	19	C4856CAC	131	CWL5043	138
93112	44	AH8221MID	19	C4857CAC	131	CWL5212K	118
93303	33	AH8230SUN	19	C6350	134	CWL51222	127
93501	60	AH8231SUN	19	C6350A	134	CWL52210	118, 130
93502	60	AH8240CB	19	C6355	134	CWL52450	127
93504	60	AH8241CB	19	C8005W	140	D	
93977	33	AH8251CNC	19	C8006W	140	D8-577-EPKUS	158
93984	33	AH8261PAR	20	C8007W	140	D8-577-EPKUS	159
93984D	33	AH8263SUN	20	C8010	140	D24-886PKUS	158, 159
94000		AH8265TR	20	C8011	140	DF1073KB	137
94000AS	30	AH8266TR	20	CNSLPLUS-BLA	101	DF1075KB	137
94001AS	30	AH8271AB	14	CW8002K	137	DP-10	169
94005AS	30	AH8272MBC	4, 15	CWL0003	139	DS58-2BPKUS	159
94009AS	30	AH8272OBC	4, 15	CWL0004	139	DS58-3BHPKUS	158, 159
94018	43	AH8300CB	21	CWL0005	139	DS60-13060	159
94021AS	35	AH8300NEC	21	CWL0006	123	DS72-532L	159
94025	42	AH8300SPT	21	CWL0020	123	DS72-996-35FB	159
94026AS	35	AH8351CS	19	CWL0022	125	DWR5D	159
94036	42	AH8351LB	19	CWL113	120	DWR60A	159
94037	42	AH8351SF	19	CWL118	120	DWR112	159
94039	42	AH8361CA	21	CWL503	139	DWR120	159
94101	58	AH8361MID	21	CWL503TWP	139	DWR137	159
94102	38	AH8361MID	21	CWL504	139	DWRBRUSH2	159
94102N	38	AH8500CB	21	CWL504TW	139	E	
94108VA	38	AH8500NEC	21	CWL507	140	E3	175
94109VA	38	AH8500SPT	21	CWL507TW	139	EDWR-6	159
94110AS	31	AH8602BLS	15	CWL508	140	EFF-BLA	101
94114VA	38	AH8602CA	15	CWL509	139	EFF-CHA	101
94208AS	35	AH8602GO	15	CWL510	139	EMIC-BLA	101
94210AS	35	AH8800SPT	20	CWL511	123	EMIC-CHA	101
94209AS	35	AH8800SUN	20	CWL514	120	F	
96000		AH8800OTO	20	CWL515	123	F1C	175
96012X	57	AH8800WL	20	CWL518	123	F1NC	175
97000		AX4020K	136	CWL520	120	F3C	175
97370AS	35			CWL521	118	F3NC	175
				CWL522	119, 130		
				CWL522C	119		

INDEX

Part	Page	Part	Page	Part	Page	Part	Page
F8C	175	LX-1332	204	LX-1518	201	PB400000NL	219
F12-581-E	159	LX-1334	204	LX-1524	201	Q	
F12-583-EPRFB	150	LX-1336	204	LX-1526	201	QP48-14180	148, 159
F14-583-EP	159	LX-1338	205	LX-1528	201	QP72-999CT	153, 159
F14-999CT	153, 159	LX-1339	204	LX-1530	201	S	
F15-580-EP	151, 159	LX-1341	205	LX-1532	201	S8-999PV	151
F15C	175	LX-1342	204	LX-1534	201	S12-530RFB	151
F16-511-E	151, 159	LX-1346	205	LX-1536	201	S12-577-EPKUS	158
F20-532	154, 159	LX-1348	205	LX-1538	201	S12-580-EP	151
F20-996-35	159	LX-1352	204	LX-1618	201	S12-583EPRFB	150
F24-523	159	LX-1360	206	LX-1624	201	S16-511-E	151
F24-530RFB	159	LX-1361	206	LX-1626	201	S16-999CT	153
F24-996-35FB	153, 159	LX-1362	206	LX-1638	209	S18-518FB	152, 154
H		LX-1362-20	206	LX-1640	209	S24-523FB	154
HN8000BB	13	LX-1363	206	LX-1700	209	S24-527PKUS	158
HN8001BB	13	LX-1364	206	LX-1702	209	S24-530RFB	152, 154
HN8200BB	12	LX-1366	206	LX-1704	209	S24-532	154
HN8220BB	12	LX-1369	206	LX-1705	209	S24-582-EPSZFB	150, 152
L		LX-1370	206	LX-1706	209	S24-994RFB	155
LX-1100	185	LX-1371	205	LX-1708	209	S24-996-35	153
LX-1112	185	LX-1374	205	LX-1708T	209	S24-996-35FB	153
LX-1120	185	LX-1375	206	LX-1709	209	S30-886PKUS	158
LX-1123	185	LX-1377	206	LX-1710	209	SC-BLA	101
LX-1142	185	LX-1378	206	LX-1712	209	SC-CHA	101
LX-1150	187	LX-1382	206	LX-1713	209	SMT	103
LX-1152	187	LX-1386	207	LX-1716	209	SPINNER-4W	159
LX-1153	187	LX-1387	207	LX-1722	209		
LX-1160	186	LX-1388	207	LX-1724	207		
LX-1161	186	LX-1389	207	LX-1725	207		
LX-1168	191	LX-1400	189	LX-1726	207		
LX-1172	187	LX-1400-2	189	LX-1727	207	T	
LX-1174	187	LX-1400-6	189	LX-1728	207	TRASH10-BLA	102
LX-1185	187	LX-1400-60	189	LX-1900	187	TRASH-BLA	102
LX-1186	191	LX-1401	189	LX-1901	187	TS10T6	53
LX-1188	191	LX-1402	189	LX-3007	194	TS20T6	53
LX-1201	190	LX-1403	189	LX-3013	194	TS40T6	53
LX-1203	190	LX-1403-XL	189	LX-3019	194	TS60T6	53
LX-1205	190	LX-1404	189	LX-3101	194	TS70T6	53
LX-1207	190	LX-1406	189	LX-3113	194	TS75T6	53
LX-1207-C	190	LX-1407	189	LX-3117	194	TS80T6	53
LX-1209	190	LX-1409	191	LX-3119	194	TS85T6	53
LX-1211	190	LX-1410	191	LX-3121	194	TS90T6	53
LX-1212	190	LX-1411	191	LX-3201	195	TS95T4	53
LX-1214	190	LX-1412	191	LX-3301	196	V	
LX-1300	204	LX-1413	191	LX-3303	196	VENT-05	101
LX-1300-RH	204	LX-1414	191	LX-3305	196	VSR	102
LX-1301	204	LX-1415	191	LX-3307	196	W	
LX-1302	204	LX-1416	190	LX-3311	196	WS1524	60
LX-1310	191	LX-1418	191	LX-3313	196	WS1524A	59
LX-1311	207	LX-1420	190	LX-3315	196	WS1524U	59
LX-1312	207	LX-1422	190	LX-3317	196	WS2024	60
LX-1313	207	LX-1426	199	LX-3505	195	WS2024A	59
LX-1314	207	LX-1428	199	LX-3511	195	WS2024U	59
LX-1316	203	LX-1430	199	LX-4851	189	WS4212	60
LX-1318	203	LX-1434	191	LX-4851-3010	189	WS4224U	59
LX-1320	203	LX-1436	205	M		WSE-39A	59
LX-1321	203	LX-1436-DB	205	MM510	137	WSH24	60
LX-1322	203	LX-1450	199	N		Z	
LX-1323	203	LX-1452	199	N005W	137	ZE3	175
LX-1324	203	LX-1454	199	O			
LX-1326	203	LX-1458	199	OP-1	169		
LX-1327	203	LX-1460	199	OP-112	169		
LX-1328	203	LX-1462	199	P			
LX-1329	203	LX-1470	190	PB40000	219		
LX-1330	204	LX-1500	201				
LX-1331	204	LX-1502	201				
		LX-1510	201				
		LX-1514	201				

CONTACT INFORMATION



(800) 524-1458 / Emporia, KS

(800) 527-3465 / Torrance, CA

Fax: (800) 444-6779

Email: sales@HopkinsMfg.com

Email: techsupport@HopkinsMfg.com

HOPKINS MANUFACTURING CORPORATION

428 Peyton Street, P.O. Box 1157

Emporia, Kansas 66801-1157 (620) 342-7320

www.HopkinsMfg.com | www.HopkinsTowingSolutions.com

TRADEMARKS

The following list of product names and brands are the trademarks or registered trademarks of Hopkins Manufacturing Corporation unless otherwise noted. All rights reserved: Hopkins®, the Hopkins logo, The Image of Difference™, Hopkins Towing Solutions® and logo, Juice Performance™ and the Juice logo, GoGear® and the GoGear logo, FloTool® and the FloTool logo, nVISION® and the nVISION logo, SubZero® and the SubZero logo, Mallory® and the Mallory logo, Cool Snow Tool™, 2x4 Basics® and the 2X4 Basics Logo, Brake Buddy®, Carrand™ and the Carrand Logo, Dial & Spray™, Trigger-Jet™, Sof-Tools™, Tuf-Spot™ Wash Mitt, Drip-Stop™ Drying Towel, Clean-Seam™ Polishing Towel, Dust-off™ Detailing Towel, Design, Smart Nozzle™, AutoSpa™, Auto-Vac™, Flow-Thru™, Suds-N-Go™, Dip-N-Brush™, Gator Skin™, Grip-Tech™, Tuf-Scrub™ Sponge, Wash-Jet™ Powerwand, The Gripper™, Spillmaster™, Storgemaster™, Drink-N-Go™, Back of Seat Organizer™, Center Seat Organizer™, Tower Organizer™, Console Plus Organizer™, Compact Plus Organizer™, Cargo Handler™, Back of Seat Plus Organizer™, Side of Seat Organizer™, Storgemaster™, Cargo Organizer™, Cargo Carrier Organizer™, Tall Pop-Up Trash Can™, Pop-Up Trash Can™, Space Saver Trash Can™, Tru-Fit™, QuickCling™ Pop Up Side Shade, Corner QuickCling™ Pop Up Side Shade, Ice Ripper™ Scraper, Ice Chisel™ Scraper, Klondike™ Ice Scraper, Bear Claw™, Talon™ Ice Scraper, Ice Crusher™ Scraper, Frostbiter™ Ice Scraper, Avalanche™ Snowbrush, Ice Hammer™ Snowbrush, Polar Vortex™, Duo-Grip™ Snowbrush, Monster™ Swivel Snowbroom, Quick Lock™ Pivoting Snowbroom, Arctic Plow™, ArcticGuard™, HotSpot™, Cinch-Lock™ Technology, SafeGuard™, Ultimate Power™, Ultra Power™, High Power™, Standard Power, Telebroom™, Quick Fill™, On/Off Spout™, Spill Saver™ Measu-Funnel™, Multi-Task 5-in-1 Funnel™, Gas Gauge Funnel™, Radiator Funnel™, Locking Oil Funnel™, Flex Funnel™, Quickfill® Funnel, Super QuickFill® Funnel, Giant Quickfill® Funnel, Super Multi-Purpose Funnel™, Big Mouth Funnel™, Utility Funnel™, Tight Spot Funnel™, No Spill Oil Spout™, No Spills, No Mess!™, Super Flexi-Spout™, Shaker Siphon™, Super Siphon™, Economy Siphon™, Multi-Purpose Transfer Pump™, The MixMaster™ Injector, Universal Drain Plug Wrench™, Jaw Style Oil Filter Wrench™, Perfect Tight Oil Filter Wrench™, Perfect Tight Adapter™, 7 Quart Heavy-Duty Oil Drain Pan™, Tighten Until it CLICKS™, Mr. Funnel®, Capless Gas Tank Funnel™, FloTool High Performance Absorbent™, 24 Quart Drain Container™, 58 Quart Drain Container™, RhinoGear™, RhinoRamps®, RhinoRamps Max®, Heavy Duty Wheel Chocks™, Heavy Duty Chock and Block™, Hand-E Hauler™, Dispos-Oil™, Back-Up Alert™, SmartZone™, Trailblazer Electronic Deer Alert™, Make It Any Size™, Dekmate®, AnySize Chair®, AnySize Table™, Flip-Top Table™, ShelfLinks®, Pro Brackets™, StudTrack™, The Smarter And Fresher Choice™, Bell Automotive Products™ and the BELL Automotive Logo, "Enjoy your ride!"™, Bellaire®, MonkeyGrip™ and the MonkeyGrip Logo, "Nothing Grips Like the Monkey!"™, Victor™, the Victor Logo and "King of the road!"™, Genuine Victor™, the Genuine Victor Logo, Tight-Spot™, Scrub-Tuf™, ClearView™, OutShine™, Multi-Purpose Cleaning Wipes™, Tanner's Select®, the Tanner's Select logo, HyperFIT™, HyperFLEX™, QuickDRIVE™, QuickDRIVE PRO™, QuickFIX™, QuickDRIVE MAXX™, SmartTIP™, SmartSTOP™, SmartSTOP Outdoor™, AutoSTOP™, AutoSTOP ULTRA™, AutoSTOP OUTDOOR™, HyperDRIVE™, HyperDRIVE PRO™, HyperDRIVE MAX™, SpeedPlug™, Matrix Camo™, BLAZER™, BLAZER International®, and the Blazer International logo, AXXENT™, BAJA®, vueSMART™ Wireless Trailer Camera™, SmartHitch™, FORCE™, MAXX-Force™, MAXX-Force Series™, Lumax®, Total Liquid Protection™



WHAT DRIVES US, DRIVES YOUR GROWTH™

For More Information Call

(800) 524-1458 / Fax: (800) 444-6779 / Email: sales@HopkinsMfg.com

Technical Support

(800) 835-0129 / techsupport@HopkinsMfg.com



The ARM & HAMMER trademarks and the distinctive orange trade dress are owned by Church & Dwight Co., Inc., and are used by Hopkins Manufacturing Corporation under license. The OXICLEAN and Odor Blasters trademarks are owned by Church & Dwight Co., Inc., and are used by Hopkins Manufacturing Corporation under license. The Mossy Oak logo and trademarks are the licensed property of Haas Outdoors, Inc. and are used under license by Hopkins Manufacturing Corporation. The Rain-X trademarks are licensed property owned by Illinois Tool Works, Inc. and are used under license by Hopkins Manufacturing Corporation. The Body Glove logo and trademarks are the licensed property of Marquee Brands and are used under license by Hopkins Manufacturing Corporation. The DGA logo and David Gonzalez Art are the trademarks of DGA Tees, Inc. and are used under license by Hopkins Manufacturing Corporation. HOONIGAN and HOONIGAN Logo are used under license by Hopkins Manufacturing Corporation. All Rights Reserved.

HOPKINS MANUFACTURING CORPORATION

428 PEYTON STREET, P.O. BOX 1157 | EMPORIA, KANSAS 66801-1157 | (620) 342-7320
© 2024 Hopkins Manufacturing Corporation • Printed in U.S.A. • 800-1713 -023 Rev. A 1/24